

60W 1Phase Plastic



Features:

- Ease of wire connection to terminals
- Compact design for easy handling
- Overload protection
- Over voltage protection
- Thermal protection
- Power boost 150% for 3 seconds
- Expected life time: 10 years
- Redundancy: Yes (with external oring diode)
- RoHS compliant output terminals for fast wiring and easy installation.

DRP024V060W1AZ

Summary

The new CliQ DRP024V060W1AZ is the latest offering from one of the world's largest power supply manufacturers -Delta.

The product offers a nominal output voltage of 24V, a wide temperature range from -20°C to +75°C and a minimum holdup time of 20ms.

The state-of-the-art design is made to withstand harsh industrial environments. The rugged, ultra-compact plastic case is shock and vibration resistant according to IEC60068-2.

The 60watts CliQ DIN Rail power supply provides over voltage, overload and thermal protection.

Due to the wide input voltage range from 85 to 264Vac, the Delta's CliQ power supply is worldwide usable.





Multiple output terminals for fast wiring and easy installation.



Technical Data

60W1Ph Plastic	
Input Data (1)	
Nominal input voltage (wide-range input)	100-240VAC
Input Voltage range	85-264VAC (DC input range 120-375 VDC)
Frequency	47-63Hz (0Hz at DC input)
Current consumption (at nominal values)	1.1A @ 115VAC, 0.7A @ 230VAC
Inrush current limitation. I ² t (+25 °C) typ.	<40A @ 115VAC, <80A @ 230VAC
Mains buffering at nominal load (typ.)	>20ms @ 115VAC, > 125ms @230VAC
Turn-on time after applying the mains voltage	<2.5Secs.
Transient surge voltage protection	VARISTOR
Input fuse, internal (device protection)	T 3.15 AH / 250 V
Recommended backup fuse power circuit-breaker characteristic	6A, 10A or 16A, B.
Discharge current to PE	<1mA
Connection Method	Screw Connection.
Stripping Length	7 mm or use suitable lug to crimp

Output Data (2)	
Nominal output voltage U _N / tolerance	24VDC±2%
Setting range of the output voltage	22-28VDC
Nominal output current I _N with convection cooling:-20 to +50°C	2.5A
Derating above +50°C	2.5% / K. (< 0°C 1% / K., > 70°C 4% / K.)
Current limitation at short-circuits approx.	I _{SURGE} = 150% of P _O Max typically.
Startup with capacitive loads	Max 8,000µF
Max. power dissipation idling/nominal load approx.	10W
Efficiency (at 115VAC and nominal values)	>85% typical.
Residual ripple/ peak switching (20 MHz) (at nominal values)	<50mV / <240mVpp
Can be connected in parallel for redundancy and increased capacity	YES with oring Diode.
Surge voltage protection against internal surge voltages	YES

Certification/Standards	
Electrical equipments of machines	IEC60204-1 (over voltage category III)
Electronic equipment for use in electrical power installations	EN 50178 / IEC62103
Safety entry low voltage	PELV (EN 60204), SELV (EN 60950)
Electrical safety (of information technology equipment)	EN60950-1 (GS-mark), UL/C-UL recognized to UL60950-1, CSA C22.2 No.60950-1, CB scheme to IEC60950-1, cCSAus to UL60950-1 and CSA C22.2 No.60950-1 (file no.181564)
Industrial control equipment	UL / C-UL listed to UL508 and CSA C22.2 No.107.1-01 CSA to CSA C22.2 No.107.1-01 (file no.181564)
Protection against electric shock	DIN 57100-410
CE	In conformance with EMC directive 2004/108/EC and low voltage directive 2006/95/EC
ITE	EN55022, EN61000-3-2, EN61000-3-3, EN55024
Industrial	EN55011
Limitation of mains harmonic currents	DIN57100-410
	    
RoHS Compliant	Yes



General Data		
Isolation voltage:		
Input / output	type test/routine test	4 KVAC / 3 KVAC
Input / PE	type test/routine test	1.5 KVAC / 1.5 KVAC
output / PE	type test/routine test	1.5 KVAC / 500 VAC
Degree of protection		IPX0
Class of protection		Class I with PE connection
MTBF		>800,000 hrs.
Type of housing		Plastic (PC), closed
Dimensions (W / H / D) + mounting rail		32mmx113mmx120.6mm
Weight		0.32Kg approx
STATUS Indicator		
LED (6) DC OUTPUT OK		YES (GREEN LED)
Climatic Data		
Ambient temperature (Operating)		-20°C to 75°C (>50°C derating)
Ambient temperature (Storage)		-25°C to 85°C
Humidity	at+25 °C, no condensation	<95% RH
Vibration (Operating)		10 to 150Hz, 0.35mm acc 50m/S ² Single amplitude(5G max) for 90min in each X,Y & Z directions, in acc with IEC68-2-6
Shock (in all directions)		30G (300mls2)in all directions according to IEC68-2-27
Pollution degree		2
Climatic class		3K3 according to EN 60721
In conformance with EMC guideline 89/336/EEC and low voltage directive 73/23/EEC EMC (electromagnetic compatibility)		DINRAIL 1AC / 24V DC / 2.5A (D0116888)
Immunity to interference according to EN 61000-6-2		
<ul style="list-style-type: none"> EN 61000-4-2²⁾ Discharge of static electricity (ESD) 	Housing Contact discharge: Discharge in air:	LEVEL 4 8 KV 15 KV
<ul style="list-style-type: none"> EN 61000-4-3¹⁾ Electromagnetic HF field 	Housing Frequency/Field intensity:	LEVEL 3 80MHz - 14 Hz / 10v/m,with 1kHz tone/80% modulation
<ul style="list-style-type: none"> EN 61000-4-4²⁾ Fast transients (Burst): 	Input: Output: Signal:	2KV ⁴⁾ - -
<ul style="list-style-type: none"> EN 61000-4-5²⁾ Surge voltage capacities (Surge): 	Input: Output: Signal:	2KV ³⁾ / 2KV ⁴⁾ (Level 3) - -
<ul style="list-style-type: none"> EN 61000-4-6¹⁾ Conducted disturbance 	I/O: Frequency / U _o :	Level 3 0.15MHz - 80MHz / 10Vrms.
<ul style="list-style-type: none"> EN 61000-4-11²⁾ Voltage dips 		Input : Main Buffering > 20ms.
Noise emission according to EN 6100-6-3 <ul style="list-style-type: none"> Emitted radio interface Radio interference voltage 		EN55011 (EN55022) CLASS B ⁵⁾ EN55011 (EN55022) CLASS B ⁵⁾
EN55011 corresponds to CISPR11 / EN55022 corresponds to CISPR22 / EM 61000 corresponds to IEC 1000 1) Criterion A: Normal operating behavior within the defined limits. 2) Criterion B: Temporary impairment to operational behavior that is corrected by the device itself. 3) Symmetrical: Conductor to conductor. 4) Asymmetrical: Conductor to ground. 5) Class B: Area of application industry and residential.		



Numbering for DinRail Power Supply

For example: **DRP024V060W1AZ**

XX X XXXX XXXX X XX

XX.....**Product Type**

DR	DinRail
----	---------

XX **X** XXXX XXXX X XX

X.....**Model**

P	Power Supply
---	--------------

XX X **XXXX** XXXX X XX

XXXX.....**Voltage**

024V	24 Voltage
------	------------

XX X XXXX **XXXX** X XX

XXXX.....**Watt**

060W	60 Watt
120W	120 Watt
240W	240 Watt
480W	480 Watt

XX X XXXX XXXX **X** XX

X.....**Phase**

1	1 Phase
3	3 Phase

XX X XXXX XXXX X **XX**
XX.....**Variation (Eg, Customer, material,Etc.)**

AA	Delta standard – metal case
AZ	Delta standard – plastic case

Block Diagrams/Connections:

Block Diagram of Power Supply,

- DRP024V060W1AZ

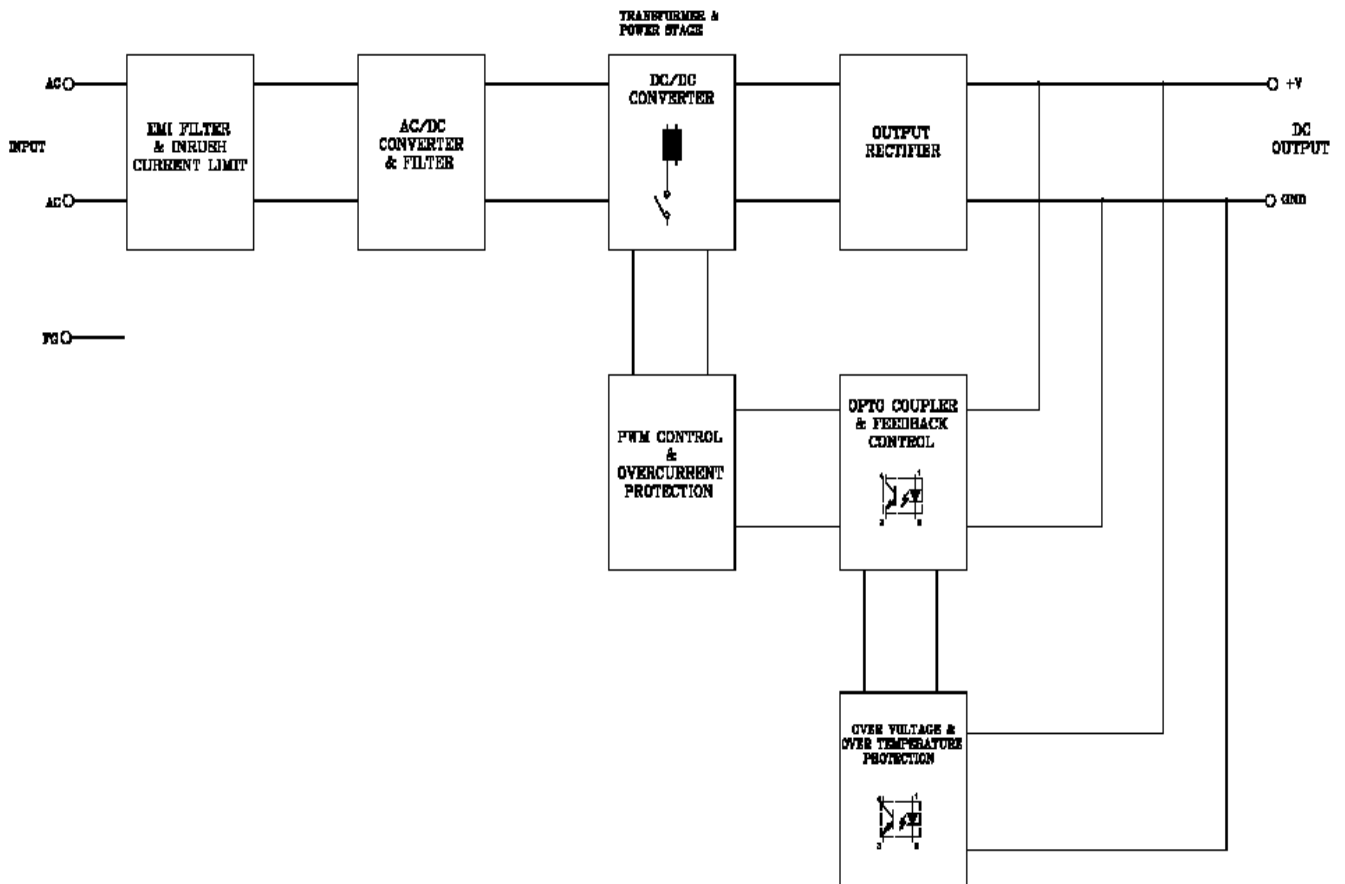

Engineering Data

- **Derating Curve**
 - **Model: DRP024V060W1AZ**

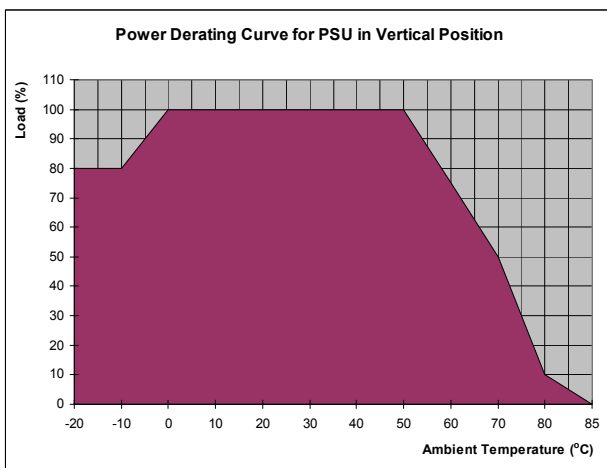

Note:

1. Do not use the Power Supply in areas outside the shaded portion as shown in the above graph, internal parts may occasionally deteriorate or be damaged.
2. For the power derating refer above graph ambient temperature $> 50^{\circ}\text{C}$, the output capacity has to be reduced by 2.5% per Kelvin increase in temperature. If the output capacity is not reduced when $\text{Amb} > 50^{\circ}\text{C}$ device will run into thermal protection by switching off i.e. device will go in bouncing mode and will recover when Amb is lowered or load is reduced as far as necessary to keep device in working condition.
3. If the power supply has to be mounted in any other direction please contact your service provider.
4. In order for the device to function in the manner intended, it is also necessary to observe lateral spacing of 2 cm to other modules.
5. Depending on the ambient temperature and load of the device, the temperature of the housing can become very high!

Mechanical drawing

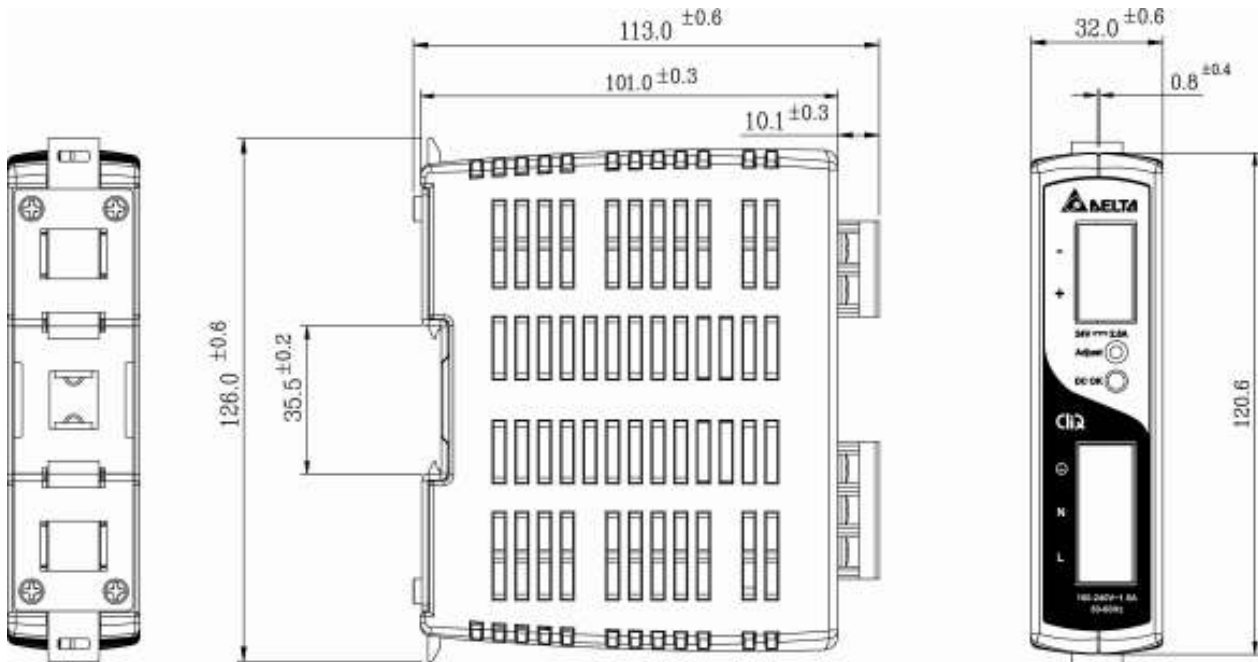

Device description (Fig. 1)

- (1) Input terminal block connector
- (2) Output terminal block connector
- (3) DC voltage adjustment potentiometer
- (4) DC OK control LED (green)
- (5) Universal mounting rail system

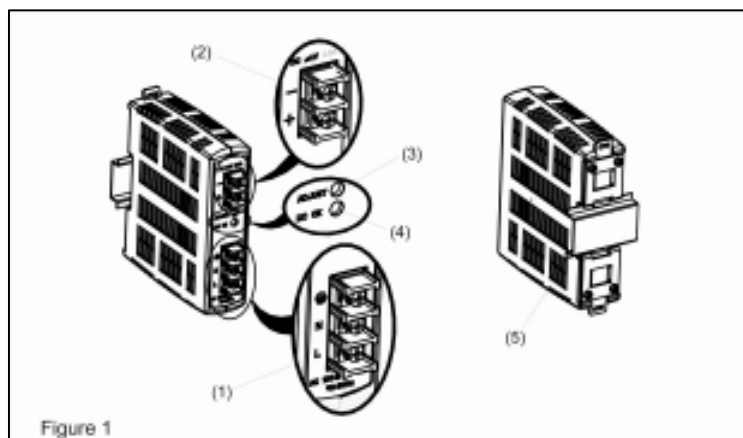

- **Over Load Protection**

The Power Supply is provided with an overload protection (OLP/OCP) function which protects the power supply from possible damage by over current. Additionally power supply also has over temperature protection (OTP) in case the over load condition persists for a longer duration and is below the overload trigger point but > 100% load.

Typically the over load current (I_{OL}) is > I_{SURGE} (150%) output voltage will start drooping down when the power supply reaches max power limit and will run into bouncing mode when the output reaches UVLO (under voltage point). The output voltage will recover automatically when the overload condition is removed.

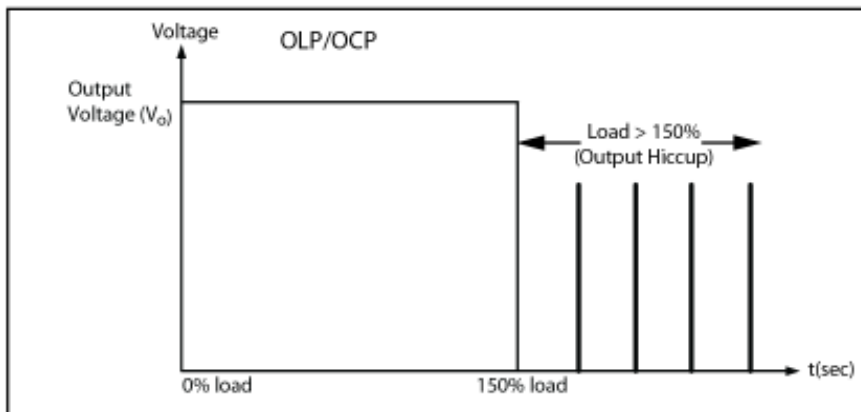

- **Short Circuit Protection**

The Power Supply also has a short circuit protection which is in line with the overload protection and activates whenever there is a short across the output voltage, output goes in bouncing mode and remains until the fault is removed.

- **Over Temperature Protection**

Additionally power supply also has over temperature protection (OTP) as mentioned above this OTP comes into picture when the over load condition persists for a longer duration and the output current level is below the overload trigger point but > 100% load.

Also in the event of a higher ambient operating condition with 100% load the power supply will run into OTP when the Ambient temperature is > 55°C. The protection is self recoverable when activated output voltage bounces until the operating ambient temperature of the power supply is reduced or the power supply is used within its power derating curve.

- **Over Voltage protection**

The Power Supply is protected by Over voltage in the event that power supply feedback circuit fails the output voltage will not be $>35\text{V}$ under any Line/Load and operating ambient conditions.

The unique feature about this over voltage protection (OVP) is that power supply doesn't shut down but goes in 2nd level regulation which is 30-32Vdc. The Power supply will continue to deliver the power but due to high output voltage it will be operating $> 100\%$ load ($32\text{V} \times 2.5\text{A} = 80\text{Watts}$) if this condition persists the power supply will sense OTP (Over Temperature Protection) and will go under bouncing mode. The power supply output voltage will recover back to 24Vdc once the fault condition is removed.

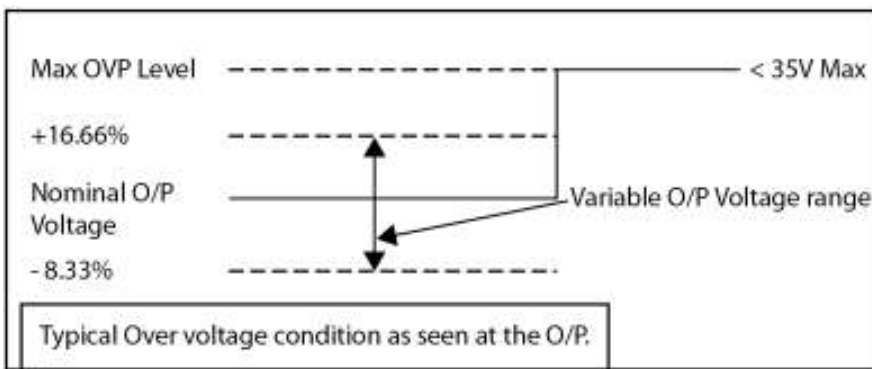

- **Inrush Current, Start Up Time, Output Hold Up Time**

Inrush Current,

Inrush current is the first surge current seen on the input side when AC input is applied to the power supply. It is the first pulse captured; see a typical picture for the Inrush current as seen in the power supply.

Start Up Time,

Start up time is measured from the point AC input is applied and the o/p voltage reaches within 90% of its set value. See picture below for a typical start up time characteristic of a power supply.

Rise Time,

Rise time is the time needed for o/p voltage to rise from 10% of its set value to 90% of its set value. See the picture below for a typical rise time measurement in a power supply.

Hold Up Time,

Hold time is the time when the AC input collapses and o/p voltage retains regulation for a certain period of time is called as hold up time. See in the picture below a typical hold up time characteristic of a power supply. The hold time is measured until the o/p voltage remains in regulation hence it measured until the o/p voltage reaches 95% of its set value.

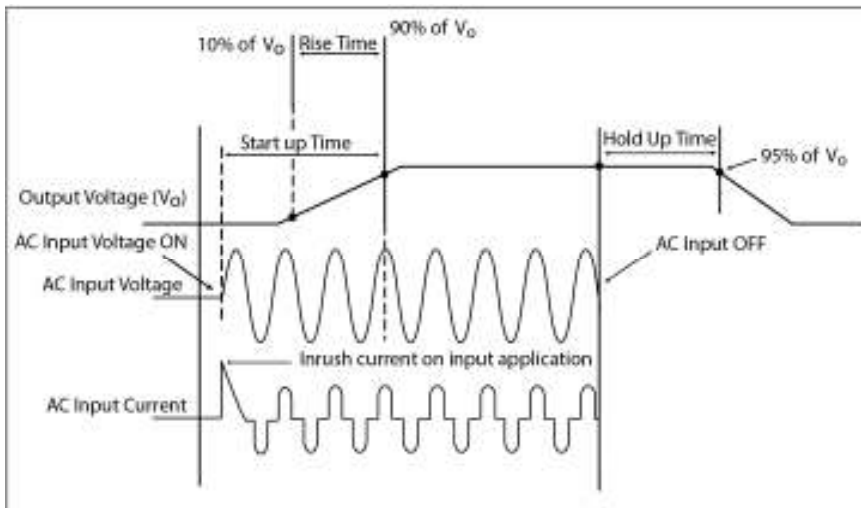

- **Output Voltage Adjust**

The 24 V DC connection is made using the "+" and "-" screw connections. At the time of delivery, the output voltage is 24 V DC. The output voltage can be set from 22 to 28 VDC on the potentiometer seen as Adjust on the front panel of each power supply.

- **Surge Load**

See below typical surge load capability of the power supply, the PSU is capable of delivering 3 secs of Surge load about 150% of I_O max the o/p voltage can be out of regulation limits of $\pm 5\%$.

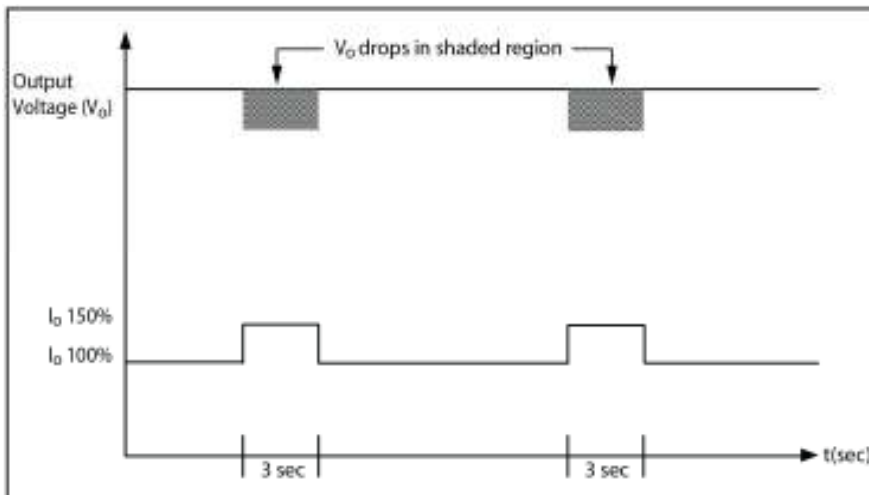

- **Dynamic Load**

Additionally power supply is capable of dynamic change of load from 0% to 100% with o/p voltage within $\pm 5\%$ of regulation limits. See below the dynamic behavior of the PSU.

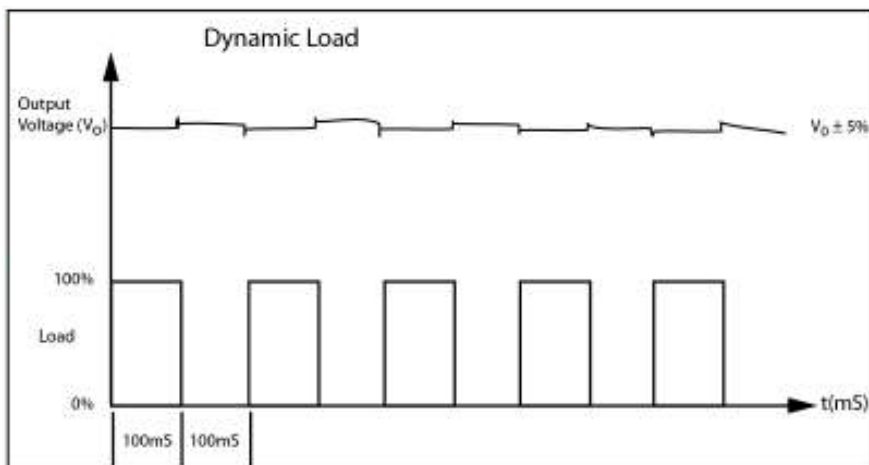

- **Redundancy & Parallel Operation with Oring Diode**

See below figure for a typical Redundant/Parallel operation of PSU using CliQ series power supplies. The 2 power supplies PSU1 & PSU 2 are connected thru a twin diode where Anode1 A1 is connected to the +Ve i.e. 24V of PSU1 and Anode2 A2 is connected to the +Ve i.e. 24V of PSU2 and the output ground GND are shorted together.

The output of these 2 power supplies PSU1 & PSU2 is drawn from the Cathode K of the twin diode thus making the power supply work in Redundant/Parallel operation.

Redundant Operation:

When 2 power supplies are connected in below manner the power supply PSU1 or PSU2 whichever has higher output voltage takes the max load and the other PSU is operating in standby (@No Load) in case of failure on PSU1, PSU2 takes over the load from PSU1 and supplies the required power to end system.

- Redundant / Parallel Operation with External Oring Diode

Redundance / Parallel Operation with External Oring Diode

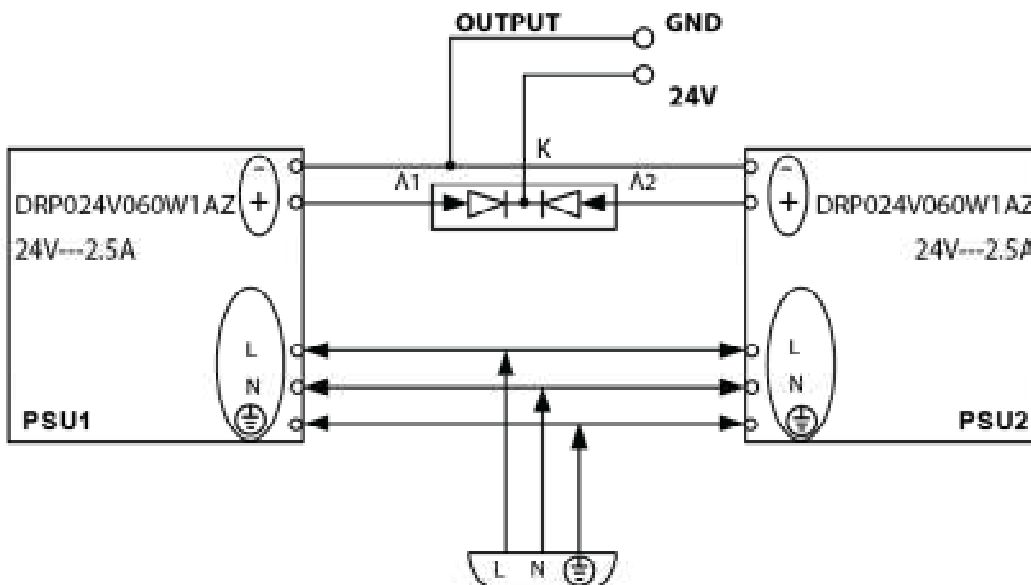
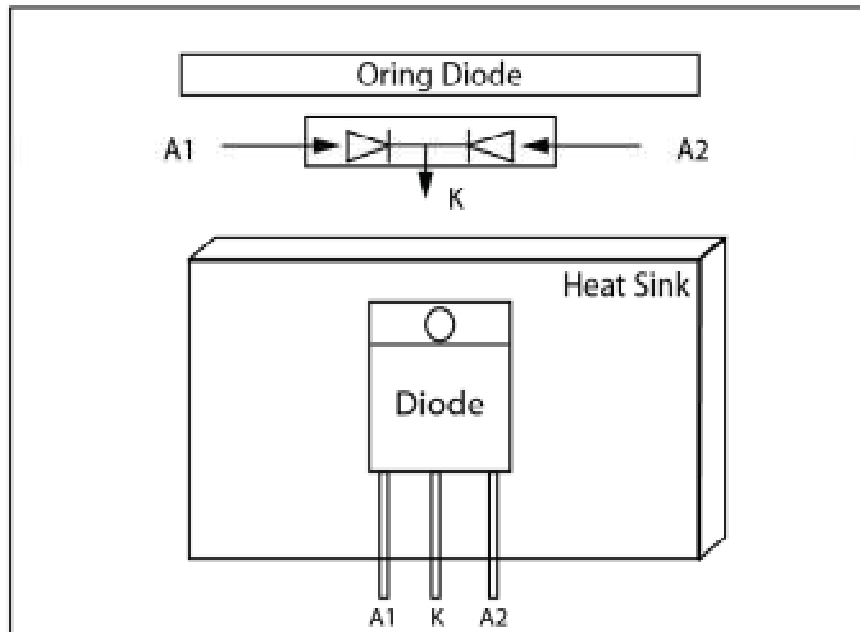

**Parallel Operation:**

When 2 power supplies are also connected in the above manner they can share the Load provided following steps are taken.

Step 1:

Measure the o/p voltages @ NL measured from A1 to Gnd i.e. VA1 to Gnd of PSU1 and VA2 to Gnd of PSU2. If the voltages are not same follow step 2, if the o/p voltages are same skip step 2 and move to step 3.

Step 2:

Adjust the o/p voltages with the help of VR available on the front panel of the PSU marked as ADJUST for both PSU1 and PSU2 at the same level for e.g. if PSU1 o/p is measuring 24.15Vdc and PSU2 is measuring 24.25Vdc adjust the o/p voltage of either PSU1 close to 24.25Vdc or adjust the o/p voltage of PSU2 close to 24.15Vdc.

Step 3:

Connect the PSU to the end system load and measure the o/p voltages from A1 to Gnd i.e. VA1 to Gnd of PSU1 and VA2 to Gnd of PSU2. Ensure that o/p voltages are same even after the 2 power supplies are connected to load. If not then adjust them with the VR available on Front panel. A tolerance of $\pm 25\text{mV}$ would be acceptable.

Note:

1. If the o/p voltage of any 1 power supply i.e. PSU1 or PSU2 is higher that power supply will take the initial load and also share the maximum load.
2. If the o/p voltages adjusted are same then an equal load current sharing between the 2 power supplies can be achieved.
3. The Oring diode must be of an appropriate rating, recommended rating of Oring Diode is minimum 4 times of the output load current and minimum reverse voltage rating of 45Vrr.
4. A suitable HS is also advised to ensure that oring Diode is not over heated and damaged.