



IFD9503

CANopen Slave Communication Module Application Manual



<http://www.delta.com.tw/industrialautomation>

Warning

- ✓ Please read this instruction carefully before use and follow this instruction to operate the device in order to prevent damages on the device or injuries to staff.
- ✓ Switch off the power before wiring.
- ✓ IFD9503 is an OPEN TYPE device and therefore should be installed in an enclosure free of airborne dust, humidity, electric shock and vibration. The enclosure should prevent non-maintenance staff from operating the device (e.g. key or specific tools are required for operating the enclosure) in case danger and damage on the device may occur.
- ✓ IFD9503 is to be used for controlling the operating machine and equipment. In order not to damage it, only qualified professional staff familiar with the structure and operation of IFD9503 can install, operate, wire and maintain it.
- ✓ DO NOT connect input AC power supply to any of the I/O terminals; otherwise serious damage may occur. Check all the wirings again before switching on the power and DO NOT touch any terminal when the power is switched on. Make sure the ground terminal ⊕ is correctly grounded in order to prevent electromagnetic interference.

Table of Contents

1	INTRODUCTION.....	3
	1.1 IFD9503 Brief	3
	1.2 Features	3
2	COMPONENTS	5
	2.1 Product Profile and Outline	5
	2.2 CANopen Connector	5
	2.3 Address Setup Rotary Switch.....	5
	2.4 Function Setup DIP switch	6
	2.5 Communication Ports on IFD9503	7
3	FUNCTIONS OF IFD9503	8
	3.1 Common Functions	8
	3.2 When IFD9503 is connected to AC motor drive	12
	3.3 When IFD9503 is connected to temperature controller (DTA/DTB)	15
	3.4 When IFD9503 is connected to ASD-A servo drive.....	19
	3.5 When IFD9503 is connected to programmable logic controller.....	22
	3.6 When IFD9503 is connected to Delta DOP-A HMI.....	26
	3.7 When IFD9503 is connected to custom equipment.....	31
4	LED INDICATORS & TROUBLE-SHOOTING.....	35
	4.1 RUN LED.....	35
	4.2 ERROR LED	35
	4.3 SCAN LED	35

5	OBJECT DICTIONARY	35
6	CONNECTION OF IFD9503 WITH OTHER EQUIPMENT	52

1 Introduction

1. To make sure that you are able to correctly install and operate IFD9503, please read this chapter carefully before starting to use IFD9503 and keep this handy for your quick reference.
2. This chapter only provides introductory information and guidelines on IFD9503. Details of CANopen protocol are not included. For more information on CANopen protocol, please refer to relevant references or literatures.
3. IFD9503 is defined as CANopen slave station communication module to be used on the connection between CANopen network and Delta programmable logic controller, Delta AC motor drive, Delta servo drive, Delta temperature controller and Delta human machine interface. In addition, the custom function of IFD9503 allows the custom equipment with Modbus protocol to connect with CANopen network.

1.1 IFD9503 Brief

1. RUN indicator and ERROR indicator display the connection status between IFD9503 and CANopen. SCAN PORT indicator displays the connection status between IFD9503 and the equipment. For more details on LED indicators, see 13.4.
2. IFD9503 sets up its node address in CANopen by two rotary switches. For more details on the switches, see 13.2.
3. Functions of DIP switches: selecting equipment connected to IFD9503, selecting communication port of IFD9503, setting up the baud rate between IFD9503 and the master. For more details on DIP switches, see 13.2.
4. CANopen interface connects IFD9503 to CANopen network. For more details, see 13.2.
5. The communication ports allows IFD9503 to connect with Delta programmable logic controller, Delta AC motor drive, Delta temperature controller, Delta servo drive, Delta human machine interface and equipment with Modbus protocol. For more details, see 13.2.

1.2 Features

1. Functions supported:
 - CAN2.0A protocol.
 - CANopen DS301 V4.02.
2. Services supported:
 - PDO (Process Data Object):
PDO1 ~ PDO8: RxPDO maps the equipment parameters writable; TxPDO maps the equipment parameters readable. PDO information is in peer for transmitting real-time data.
 - SDO (Service Data Object):
SDO information adopts "custom machine/servo" mode for configuring slave nodes and visiting the object dictionary of every node. There are two types of SDO: request SDO and response SDO.
 - SOP (Special Object Protocol):
 - Supports the default COB-ID between the connection of pre-defined master and slave.
 - Supportes broadcasting service (when the address is 0).
 - Supports SYNC service.
 - Supports Emergency service

- NMT (Network Management)
 - Supports NMT Module control.
 - Supports NMT Error control.
 - Supports Boot-up.
- Services not supported
 - Time Stamp service.

3. Specifications:

CANopen connector

Type	Removable connector (5.08mm)
Transmission method	CAN
Transmission cable	2 communication cables, 2 power cables and 1 shielded cable
Electrical isolation	500V DC

Communication

Message type	PDO
	SDO
	SYNC
	Emergency
	NMT
Baud rate	10 k bps (bit/sec.)
	20 k bps (bit/sec.)
	50 k bps (bit/sec.)
	125 k bps (bit/sec.)
	250 k bps (bit/sec.)
	500 k bps (bit/sec.)
	800 k bps (bit/sec.)
	1 M bps (bit/sec.)
Supplier ID	477

Electrical specification

CANopen voltage	11 ~ 25V DC
Safety standard	Under EN50178 standard
Certifications	CE certified and UL certified

Environment

Operation temperature	-4 ~ 122°F (-10 ~ 50°C)
Storage temperature	-4 ~ 140°F (-20 ~ 60°C)
Humidity	< 90%, (under normal pressure)
Altitude	Max. 1,000m
Shock/vibration immunity	0.5G 9 ~ 200Hz

2 Components

2.1 Product Profile and Outline

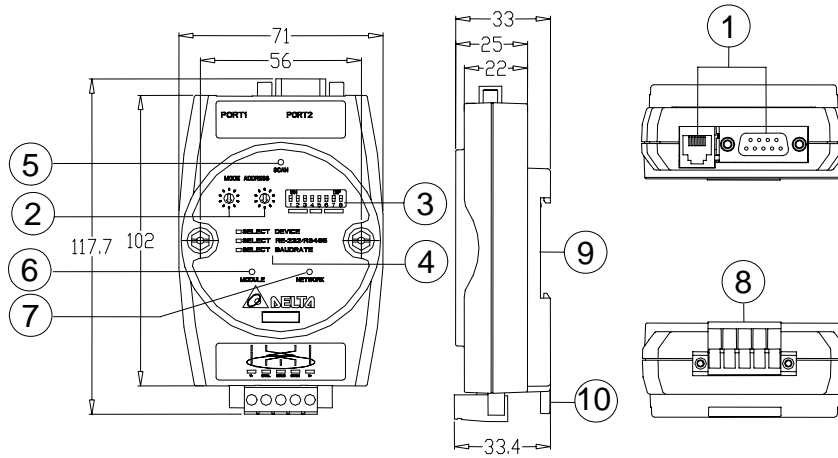

Unit: mm

1. Communication ports	6. RUN indicator
2. Address setup rotary switches	7. ERROR indicator
3. Function setup DIP switches	8. CANopen connector
4. Descriptions for DIP switches	9. DIN rail
5. SP (Scan Port) indicator	10. DIN rail clip

2.2 CANopen Connector

To connect with CANopen network, you can use the connector enclosed with IFD9503 or any connectors you can buy in the store for wiring.

- Connect to the bus on CANopen
- Connect to the CANopen communication port on IFD9503

PIN	Signal	Description
1	V-	0V DC
2	CAN_L	Signal-
3	SHIELD	Shielded cable
4	CAN_H	Signal+
5	V+	24V DC

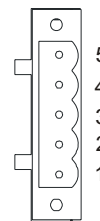

2.3 Address Setup Rotary Switch

The two rotary switches SW1 and SW2 set up the node address on CANopen network in hexadecimal form. Setup range: 01 ~ 7F (80 ~ FF are forbidden).

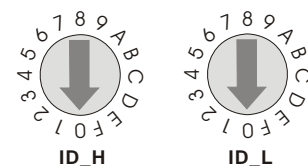

4. Example:

If you need to set the node address of IFD9503 as 26 (H'1A), simply switch the corresponding rotary switch of ID_H to "1" and the corresponding rotary switch of ID_H to "A".

Address setting	Description
0 ~ 7F	Valid CANopen node address
80 ~ FF	Invalid CANopen node address

5. Note:

The changed values on SW1 or SW2 are only valid when IFD9503 is re-powered. When IFD9503 is operating, changing the set value of node address will be invalid.

2.4 Function Setup DIP switch

The DIP switch SW3 is to be used on the equipment connected to IFD9503, the selection of communication ports and setting up the baud rate of IFD9503 and the master in CANopen.

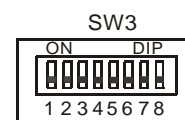

1. Selecting equipment connected to IFD9503

PIN 3	PIN 2	PIN 1	Equipment
Off	Off	On	AC motor drive
Off	On	Off	Programmable logic controller
Off	On	On	Temperature controller
On	Off	Off	Servo drive
On	Off	On	Human machine interface
On	On	Off	Custom equipment
On	On	On	Test mode

- Example

If the equipment connected to IFD9503 is Delta servo drive, you only need to switch PIN 3 in SW3 to “On”, PIN 1 and PIN 2 to “Off” and re-power IFD9503.

- Note:

The changed setting of DIP switch is only valid when IFD9503 is re-powered. When IFD9503 is operating, changing the setting of DIP switch will be invalid.

2. Selecting IFD9503 communication mode

PIN 5	PIN 4	Communication mode
Off	Off	RS-485
On	On	RS-232
Off	On	Incorrect setting
On	Off	

- Note:

The changed setting of the communication mode is only valid when IFD9503 is re-powered. When IFD9503 is operating, changing the setting of communication mode will be invalid.

3. Setting up baud rate

PIN 8	PIN 7	PIN 6	Baud rate
Off	Off	Off	10k bps
Off	Off	On	20k bps

PIN 8	PIN 7	PIN 6	Baud rate
Off	On	Off	50k bps
Off	On	On	125k bps
On	Off	Off	250k bps
On	Off	On	500k bps
On	On	Off	800k bps
On	On	On	1M bps

● Note:

The changed setting of the baud rate of CANopen is only valid when IFD9503 is re-powered. When IFD9503 is operating, changing the baud rate will be invalid.

2.5 Communication Ports on IFD9503

The communication ports on IFD9503 are used for the connection the equipment (Delta programmable logic controller, Delta AC motor drive, Delta temperature controller, Delta servo drive, Delta human machine interface and custom equipment).

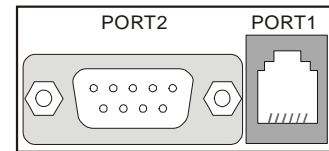

1. PORT 1 PIN definition:

PORT 1 sketch	PIN	Description
<p style="text-align: center;">PORT1</p>	1	N.C.
	2	GND
	3	DATA-
	4	DATA+
	5	N.C.
	6	N.C.

● Note:

PORT 1 supports RS-485 communication only.

2. PORT 2 PIN definition:

PORT2 sketch	PIN	RS-232	RS-485
<p style="text-align: center;">DB9 male</p>	1	N.C.	N.C.
	2	RXD	N.C.
	3	TXD	DATA-
	4	N.C.	N.C.
	5	GND	N.C.
	6	N.C.	N.C.
	7	N.C.	N.C.
	8	N.C.	DATA+
	9	N.C.	N.C.

● Note:

PORT 2 supports RS-232 and RS-485 communication only.

3 Functions of IFD9503

IFD9503 can be connected to different equipment. The functions of IFD9503 vary upon the equipment connected to it.

3.1 Common Functions

IFD9503 supports NMT, SYNC, EMERGENCY, PDO and SDO, among which the functions of NMT, SYNC and SDO are fixed, and the functions of others vary upon the equipment connected to IFD9503.

1. NMT module control

This function controls the status of node controlling NMT slave through NMT master.

- Format

Master → IFD9503

COB-ID	Byte 0	Byte 1
0 (H'000)	Command specifier (CS)	Node-ID

If Node-ID = 0, the “command specifier” will be broadcasted to all IFD9503 (CANopen slaves). Every slave will have to execute NMT.

- Commands

See below for the functions of all command specifiers:

Command specifier (CS)	Function
H'01	Enable remote node
H'02	Disable remote node
H'80	Enter pre-operation status
H'81	Reset application layer
H'82	Reset communication

- Explanation

Switching IFD9503 whose node ID = 6 to pre-operation status.

COB-ID	Byte 0	Byte 1
H'000	H'80	H'06

2. NMT error control

This function is applicable to NMT slave node sending its own operational status back to NMT master.

- After IFD9503 is initialized and enters pre-operation status, IFD9503 will send out the only BOOT-UP signal.

IFD9503 → master

COB-ID	Byte 0
1792(H'700)+Node-ID	H'00

- Supposed IFD9503 sends out one status signal during the operation, its format will be:

IFD9503 → master

COB-ID	Byte 0
1792(H'700)+Node-ID	NMT status

NMT status:

Stop: H'04; Operation in progress: H'05; Pre-operation: H'7F.

- Explanation: Assume the Node-ID of a IFD9503 is 6

When IFD9503 operation is in progress:

COB-ID	Byte 0
H'706	H'05

When IFD9503 is shut down:

COB-ID	Byte 0
H'706	H'04

When IFD9503 is in pre-operation status:

COB-ID	Byte 0
H'706	H'7F

Communication reset or application layer reset:

COB-ID	Byte 0
H'706	H'00

3. Synchronous signal -- SYNC

SYNC signal is sent out by the loop of CANopen master. SYNC does not contain any data, and its main purpose is to request the PDO of slave node to operate in synchronous communication mode. In this way, you can set to synchronous or asynchronous mode while using PDO.

- Format

Master → IFD9503

COB-ID
128(H'080)

4. SDO service

All SDO message are fixed at 8 bytes.

- Request: Master → IFD9503

COB-ID	Byte 0	Byte 1	Byte 2	Byte 3	Byte 4	Byte 5	Byte 6	Byte 7
1536(H'600) +Node-ID	Request code	Object index		Sub-index of object	Request data			
		LSB	MSB		bit7-0	bit15-8	bit23-16	bit31-24

- Response: IFD9503 → master

COB-ID	Byte 0	Byte 1	Byte 2	Byte 3	Byte 4	Byte 5	Byte 6	Byte 7
1408(H'580) +Node-ID	Response code	Object index		Sub-index of object	Response data			
		LSB	MSB		bit7-0	bit15-8	bit23-16	bit31-24

- If the “request code” (or “response code”) is different, the corresponding “request data” (or “response data”) will also be different. See the table below.

Request code	Explanation	Byte 4	Byte 5	Byte 6	Byte 7
H'23	Write a 4-byte datum	bit7-0	bit15-8	bit23-16	bit31-24
H'2B	Write a 2-byte datum	bit7-0	bit15-8	H'00	H'00
H'2F	Write a 1-byte datum	bit7-0	H'00	H'00	H'00

Request code	Explanation	Byte 4	Byte 5	Byte 6	Byte 7
H'40	Read data	H'00	H'00	H'00	H'00
H'80	Stop the current SDO command	H'00	H'00	H'00	H'00

Response code	Instruction explanation	Byte 4	Byte 5	Byte 6	Byte 7
H'43	Read 4-byte data	bit7-0	bit15-8	bit23-16	bit31-24
H'4B	Read 2-byte data	bit7-0	bit15-8	H'00	H'00
H'4F	Read 1-byte data	bit7-0	H'00	H'00	H'00
H'60	Read 1/2/4-byte data	H'00	H'00	H'00	H'00
H'80	Stop SDO command	End code			

- When IFD9503 detects an SDO error, SDO data transmission will be terminated, and IFD9503 will respond SDO master with an end code. See the table below for all end codes:

End code (16#)		Description
0503	0000	Transmission in sections: "toggle bit" has not been changed
0504	0000	SDO protocol time-out
0504	0001	"Request code" is invalid or unknown
0504	0002	Invalid block length (in block mode)
0504	0003	Invalid serial number (in block mode)
0504	0004	CRC error (in block mode)
0504	0005	Memory is full
0601	0000	When polling an object parameter, a polling fault appears
0601	0001	Try to execute reading request to a write only parameter
0601	0002	Try to execute writing request to a read only parameter
0602	0000	The requested index object does not exist in the object dictionary
0604	0041	Object parameters could not be mapped into PDO
0604	0042	The number or length of the parameters to be mapped have exceeded the maximum PDO's length
0604	0043	Common parameters are incompatible
0604	0047	AC motor drive is incompatible inside
0606	0000	Polling fails because of hardware error.
0607	0010	Data type doesn't match; the length of service parameters doesn't match
0607	0012	Data type doesn't match; the length of service parameters is too long
0607	0013	Data type doesn't match; the length of service parameters is too short
0609	0011	Sub-index doesn't exist.
0609	0030	Having exceeded the parameters' value selection range (only for writing authority)
0609	0031	Written parameters are too big
0609	0032	Written parameters are too small
0609	0036	The maximum value of the parameter is less than the minimum value
0800	0000	General error occurs
0800	0020	Parameters could not be transmitted to or stored to application layer

End code (16#)		Description
0800	0021	For the reason of local control, parameters could not be transmitted to or stored to application layer
0800	0022	Because of the present status of AC motor drive, parameters could not be transmitted or stored to application layer
0800	0023	Dynamic creating of the object dictionary fails or object dictionary does not exit (e.g. object dictionary was created from a file, if this file has an error, then the creating of object dictionary will fail)

- Explanation: Supposed there is a slave IFD9503 (Node-ID = 6)

1. Read the ID of the IFD9503 supplier (index H'1018, sub-index H'01)

Master → IFD9503:

COB-ID	Byte 0	Byte 1	Byte 2	Byte 3	Byte 4	Byte 5	Byte 6	Byte 7
H'606	H'40	H'18	H'10	H'01	H'00	H'00	H'00	H'00

IFD9503 → master:

COB-ID	Byte 0	Byte 1	Byte 2	Byte 3	Byte 4	Byte 5	Byte 6	Byte 7
H'586	H'43	H'18	H'10	H'01	H'DD	H'01	H'00	H'00

2. Read the maximum output frequency of AC motor drive (index 2001H, sub index 01H, supposed the value is 60.00Hz)

Master → IFD9503:

COB-ID	Byte 0	Byte 1	Byte 2	Byte 3	Byte 4	Byte 5	Byte 6	Byte 7
H'606	H'40	H'01	H'20	H'01	H'00	H'00	H'00	H'00

IFD9503 → master:

COB-ID	Byte 0	Byte 1	Byte 2	Byte 3	Byte 4	Byte 5	Byte 6	Byte 7
H'586	H'4B	H'01	H'20	H'01	H'70	H'17	H'00	H'00

3. Write the maximum output frequency of AC motor drive (supposed the value is 50.00Hz)

Master → IFD9503:

COB-ID	Byte 0	Byte 1	Byte 2	Byte 3	Byte 4	Byte 5	Byte 6	Byte 7
H'606	H'2B	H'01	H'20	H'01	H'88	H'13	H'00	H'00

IFD9503 → master:

COB-ID	Byte 0	Byte 1	Byte 2	Byte 3	Byte 4	Byte 5	Byte 6	Byte 7
H'586	H'60	H'01	H'20	H'01	H'00	H'00	H'00	H'00

4. Index 1408 does not exist. If you read or write 1408/01, IFD9503 will respond with an end code.

Master → IFD9503:

COB-ID	Byte 0	Byte 1	Byte 2	Byte 3	Byte 4	Byte 5	Byte 6	Byte 7
H'606	H'2B	H'08	H'14	H'01	H'88	H'13	H'00	H'00

IFD9503 → master:

COB-ID	Byte 0	Byte 1	Byte 2	Byte 3	Byte 4	Byte 5	Byte 6	Byte 7
H'586	H'80	H'08	H'14	H'01	H'00	H'00	H'02	H'06

- Note:

When IFD9503 is connected to different equipments, see 13.5.1 “Communication Objects in Object Dictionary” for the corresponding relations between index (sub index) and equipment parameters.

3.2 When IFD9503 is connected to AC motor drive

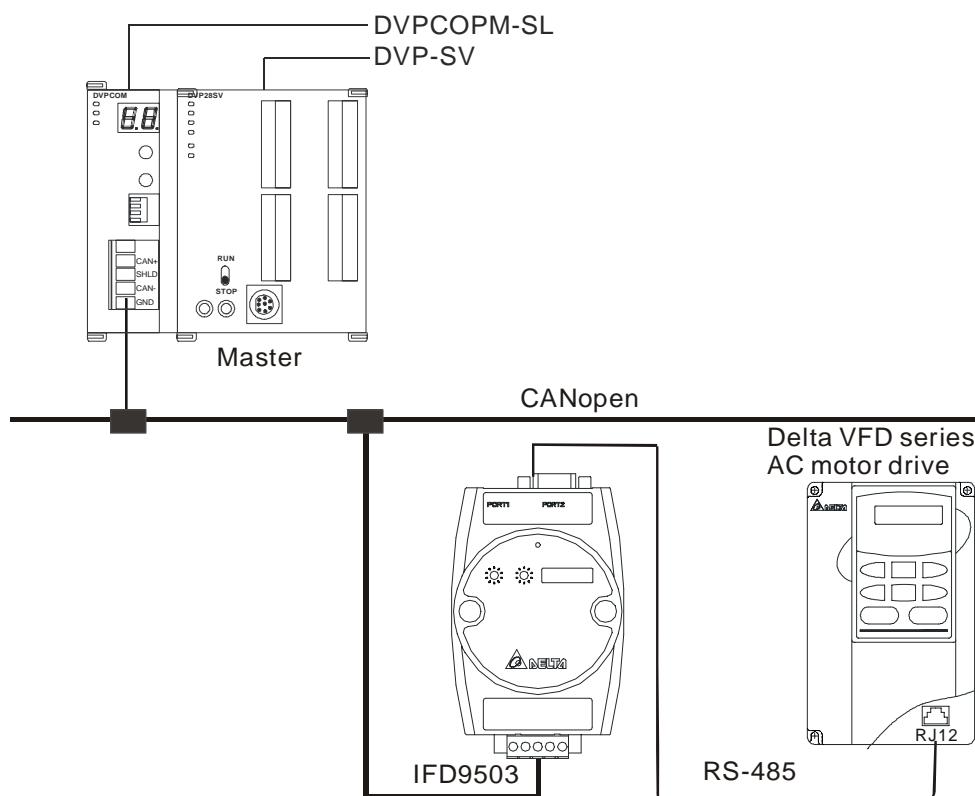

- Setting up baud rate and communication format

- Before connecting the AC motor drive to the bus, first set the communication address of the AC motor drive to 01, baud rate to 38,400bps and communication format to 8, N, 2; RTU (the format is fixed; other formats will be invalid).
- To adjust the baud rate, follow the steps listed below.
 - Set up the DIP switch SW3 of IFD9503 to custom equipment mode.
 - Connect IFD9503 to the bus of CANopen and enable the operation of IFD9503.
 - Modify the index parameter 5003/02 (main index: H'5003, sub index: H'02).
 - 5003/02 = 1 → 19,200; 8, N, 2; RTU
 - 5003/02 = 2 → 38,400; 8, N, 2; RTU (Default)
 - Return SW3 of IFD9503 back to AC drive mode and re-power IFD9503.
 - Adjust the baud rate of the AC drive to the corresponding one.

- Functions & features

In addition, IFD9503 also supports the following two functions.

- Emergency object – EMERGENCY

When IFD9503 detects an internal error, it will send an EMCY message to the CANopen bus.

- Format

IFD9503 → master

COB-ID	Byte 0	Byte 1	Byte 2	Byte 3	Byte 4	Byte 5	Byte 6	Byte 7
128(H'080) +Node-ID	Emergency error code		Error register	00	00	00	00	00
	LSB	MSB						

- Error register

The value in the error register will be mapped to index address H'1001 in the object dictionary. Value = 0 indicates that no error occurs. Value = 1 indicates that a general error takes place. Value = H'80 indicates that an internal error in the equipment occurs.

- Emergency error code

- ◆ Internal communication error

This error indicates the communication error between IFD9503 and AC motor drive (e.g. communicate failure). When such error occurs, the emergency error code will be H'8101, and the value in the error register will become 1.

- ◆ CANopen bus communication error

This error indicates the communication error between CANopen master and IFD9503 slave (e.g. master disconnection). When such error occurs, the emergency error code will be H'8130, and the value in the error register will become 1.

- ◆ Insufficient length of PDO data

This error indicates that the length of Receive PDO data actually sent out is shorter than the set data length. When such error occurs, the emergency error code will be H'8210, and the value in the error register will become 1.

- ◆ Internal error in the equipment

This error indicates the error taken place inside the AC motor drive (e.g. AC motor drive in low voltage). When such error occurs, the emergency error code will be H'FFXX (XX refers to the error code of the AC motor drive), and the value in the error register will become H'80. After the error is eliminated, the emergency error code will become H'0000.

- ◆ Eliminating error

When an error is eliminated, the emergency error code will become H'0000.

- Explanation

Take the IFD9503 slave of node ID = 6 as the object and compare the EMERGENCY messages sent out by IFD9503 in different error conditions.

- When in internal communication error

COB-ID	Byte 0	Byte 1	Byte 2	Byte 3	Byte 4	Byte 5	Byte 6	Byte 7
86	01	81	01	00	00	00	00	00

- When in CANopen bus communication error

COB-ID	Byte 0	Byte 1	Byte 2	Byte 3	Byte 4	Byte 5	Byte 6	Byte 7
86	30	81	01	00	00	00	00	00

- When in insufficient PDO data length

COB-ID	Byte 0	Byte 1	Byte 2	Byte 3	Byte 4	Byte 5	Byte 6	Byte 7
86	10	82	01	00	00	00	00	00

- When the AC motor drive in low voltage (internal error of the equipment)

COB-ID	Byte 0	Byte 1	Byte 2	Byte 3	Byte 4	Byte 5	Byte 6	Byte 7
86	0E	FF	80	00	00	00	00	00

(When in low voltage, the error code in AC motor drive will be H'0E.)

- When internal error in the equipment has been eliminated

COB-ID	Byte 0	Byte 1	Byte 2	Byte 3	Byte 4	Byte 5	Byte 6	Byte 7
86	00	00	80	00	00	00	00	00

- When the error is eliminated

Still other errors existing:

COB-ID	Byte 0	Byte 1	Byte 2	Byte 3	Byte 4	Byte 5	Byte 6	Byte 7
86	00	00	01	00	00	00	00	00

All errors are eliminated:

COB-ID	Byte 0	Byte 1	Byte 2	Byte 3	Byte 4	Byte 5	Byte 6	Byte 7
86	00	00	00	00	00	00	00	00

- Note:

IFD9503 sends out EMERGENCY message only when error occurs.

- PDO service

IFD9503 supports PDO1 ~ PDO8. For IFD9503, COB-ID of PDO can be modified but cannot be repeated.

- PDO1 (Default: Open)

- TxPDO1 (IFD9503 → master):

Send the status data of the slave (IFD9503) to the master. Preset the length of data to be mapped to 2 byte and the content to be mapped to status word. You can map any readable parameters, maximum 8 bytes.

Default COB-ID	Byte 0	Byte 1	Byte 2	Byte 3	Byte 4	Byte 5	Byte 6	Byte 7
H'180 + Node-ID	Status word							

- RxPDO1 (master → IFD9503):

Send the control data of the master to the slave (IFD9503). Preset the length of the data to be mapped to 2 bytes and the content to be mapped to control word. You can map any readable parameters, maximum 8 bytes.

Default COB-ID	Byte 0	Byte 1	Byte 2	Byte 3	Byte 4	Byte 5	Byte 6	Byte 7
H'200 + Node-ID	Control word							

■ PDO2 ~ PDO8 (Default: Close)

- TxPDO (IFD9503 → master):

Send the status data of the slave (IFD9503) to the master. Preset the length of the data to be mapped to 0 byte. You can map any readable parameters, maximum 8 bytes.

Default COB-ID	Byte 0	Byte 1	Byte 2	Byte 3	Byte 4	Byte 5	Byte 6	Byte 7
H'xxxx +Node-ID								

- RxPDO (master → IFD9503):

Send the control data of the master to the slave (IFD9503). Preset the length of the data to be mapped to 0 byte. You can map any readable parameters, maximum 8 bytes.

Default COB-ID	Byte 0	Byte 1	Byte 2	Byte 3	Byte 4	Byte 5	Byte 6	Byte 7
H'yyyy +Node-ID								

■ Data transmission mode

- TxPDO in IFD9503 supports many modes: synchronously non-cyclic, synchronously cyclic, synchronous RTR, asynchronous RTR and asynchronous modes.

3.3 When IFD9503 is connected to temperature controller (DTA/DTB)

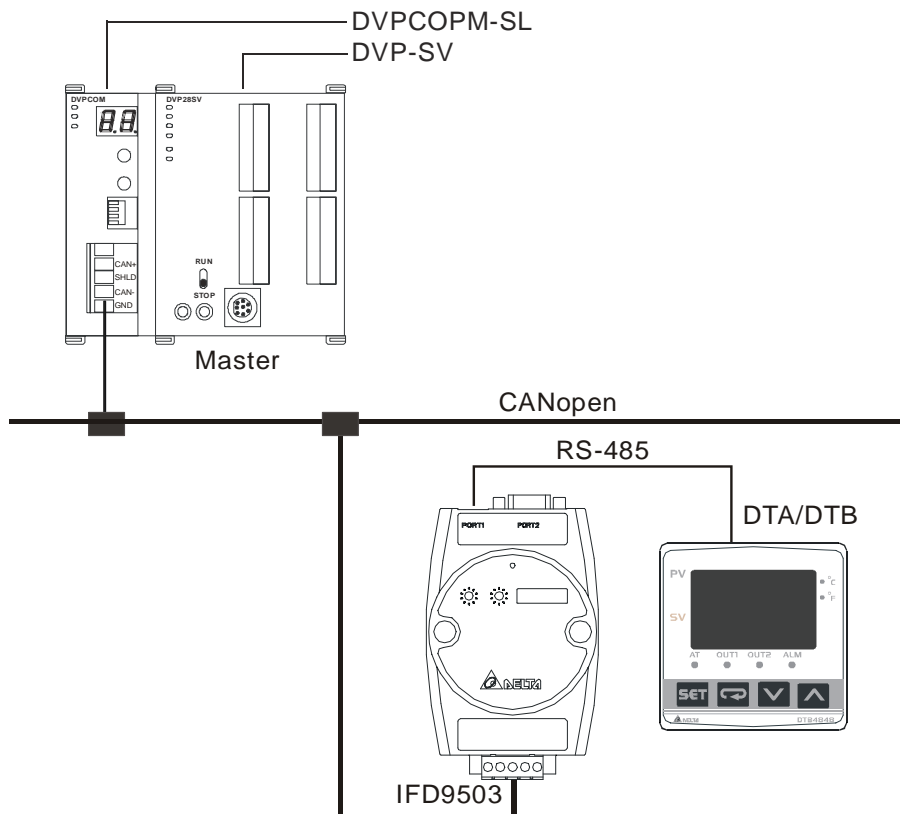

1. Setting up baud rate and communication format

- Before connecting the temperature controller to the bus, first set up the communication address of the temperature controller to 01, baud rate to 38,400bps and communication format to 7, E, 1;

ASCII (the format is fixed; other formats will be invalid).

- Before communicating with DTA series temperature controller, first set the content of H'471A to H'0001 to allow the write-in of communication.
- Before communicating with DTB series temperature controller, first set the content of H'0810 to H'FF00 to allow the write-in of communication.
- To adjust the baud rate, follow the steps listed below.
 - Set up the DIP switch SW3 of IFD9503 to custom equipment mode.
 - Connect IFD9503 to the bus of CANopen and enable the operation of IFD9503.
 - Modify the index parameter 5003/04.
 - 5003/04 = 1 → 19,200; 7, E, 1; ASCII
 - 5003/04 = 2 → 38,400; 7, E, 1; ASCII (Default)
 - Return SW3 of IFD9503 back to temperature controller mode and re-power IFD9503.
 - Adjust the baud rate of the temperature controller to the corresponding one.

2. Functions & features

In addition, IFD9503 also supports the following two functions.

- Emergency object – EMERGENCY

When IFD9503 detects an internal error, it will send an EMCY message to the CANopen bus.

- Format

IFD9503 → master

COB-ID	Byte 0	Byte 1	Byte 2	Byte 3	Byte 4	Byte 5	Byte 6	Byte 7
128(H'080) +Node-ID	Emergency error code		Error register	00	00	00	00	00
	LSB	MSB						

- Error register

The value in the error register will be mapped to index address H'1001 in the object dictionary. Value = 0 indicates that no error occurs. Value = 1 indicates that a general error takes place. Value = H'80 indicates that an internal error in the equipment occurs.

- Emergency error code

- ◆ Internal communication error

This error indicates the communication error between IFD9503 and the temperature controller (e.g. communication failure). When such error occurs, the emergency error code will be H'8101, and the value in the error register content will become 1.

- ◆ CANopen bus communication error

This error indicates the communication error between CANopen master and IFD9503 slave (e.g. master disconnection). When such error occurs, the emergency error code will be H'8130, and the value in the error register will become 1.

- ◆ Insufficient length of PDO data

This error indicates that the length of Receive PDO data actually sent out is shorter than the set data length. When such error occurs, the emergency error code will be H'8210, and the value in the error register will become 1.

- ◆ Internal error in the equipment

This error indicates the error taken place inside the temperature controller (e.g. the

temperature has not been acquired immediately after the controller is switched on).
 When such error occurs, the emergency error code will be H'FFXX (XX refers to the error code of the temperature controller), and the value in the error register will become H'80.

◆ Eliminating error

When an error is eliminated, the emergency error code will become H'0000.

■ Explanation

Take the IFD9503 slave of node ID = 6 as the object and compare the EMERGENCY messages sent out by IFD9503 in different error conditions.

- When in internal communication error

COB-ID	Byte 0	Byte 1	Byte 2	Byte 3	Byte 4	Byte 5	Byte 6	Byte 7
86	01	81	01	00	00	00	00	00

- When in CANopen bus communication error

COB-ID	Byte 0	Byte 1	Byte 2	Byte 3	Byte 4	Byte 5	Byte 6	Byte 7
86	30	81	01	00	00	00	00	00

- When in insufficient PDO data length

COB-ID	Byte 0	Byte 1	Byte 2	Byte 3	Byte 4	Byte 5	Byte 6	Byte 7
86	10	82	01	00	00	00	00	00

- When the temperature has not yet been acquired (internal error of the equipment)

COB-ID	Byte 0	Byte 1	Byte 2	Byte 3	Byte 4	Byte 5	Byte 6	Byte 7
86	02	FF	80	00	00	00	00	00

(When temperature has not been acquired, the error code in the temperature controller will be H'02.)

- When the error is eliminated.

Still other errors existing:

COB-ID	Byte 0	Byte 1	Byte 2	Byte 3	Byte 4	Byte 5	Byte 6	Byte 7
86	00	00	01	00	00	00	00	00

All errors are eliminated:

COB-ID	Byte 0	Byte 1	Byte 2	Byte 3	Byte 4	Byte 5	Byte 6	Byte 7
86	00	00	00	00	00	00	00	00

- Note:

IFD9503 sends out EMERGENCY message only when error occurs.

- PDO service

IFD9503 supports PDO1 ~ PDO8. For IFD9503, COB-ID of PDO can be modified but cannot be repeated.

- PDO1(Default: Open)

- TxPDO1 (IFD9503 → master):

Send the status data of the slave (IFD9503) to the master. Preset the length of data to be mapped to 2 bytes and the content to be mapped to present temperature value. You can map any readable parameters, maximum 8 bytes.

Default COB-ID	Byte 0	Byte 1	Byte 2	Byte 3	Byte 4	Byte 5	Byte 6	Byte 7
H'180 + Node-ID	PV							

- RxPDO1 (master → IFD9503):

Send the control data of the master to the slave (IFD9503). Preset the length of data to be mapped to 2 bytes and the content to be mapped to present temperature value. You can map any readable parameters, maximum 8 bytes.

Default COB-ID	Byte 0	Byte 1	Byte 2	Byte 3	Byte 4	Byte 5	Byte 6	Byte 7
H'200 + Node-ID	SV							

■ PDO2 ~ PDO8 (Default: Close)

- TxPDO (IFD9503 → master):

Send the status data of the slave (IFD9503) to the master. Preset the length of data to be mapped to 0 byte. You can map any readable parameter, maximum 8 bytes.

Default COB-ID	Byte 0	Byte 1	Byte 2	Byte 3	Byte 4	Byte 5	Byte 6	Byte 7
H'xxxx +Node-ID								

- RxPDO (master → IFD9503):

Send the control data of the master to the slave (IFD9503). Preset the length of the data to be mapped to 0 byte. You can map any readable parameters, maximum 8 bytes.

Default COB-ID	Byte 0	Byte 1	Byte 2	Byte 3	Byte 4	Byte 5	Byte 6	Byte 7
H'yyyy +Node-ID								

■ Data transmission mode

- TxPDO in IFD9503 supports many modes: synchronously non-cyclic, synchronous cyclic, synchronous RTR, asynchronous RTR and asynchronous modes.

3.4 When IFD9503 is connected to ASD-A servo drive

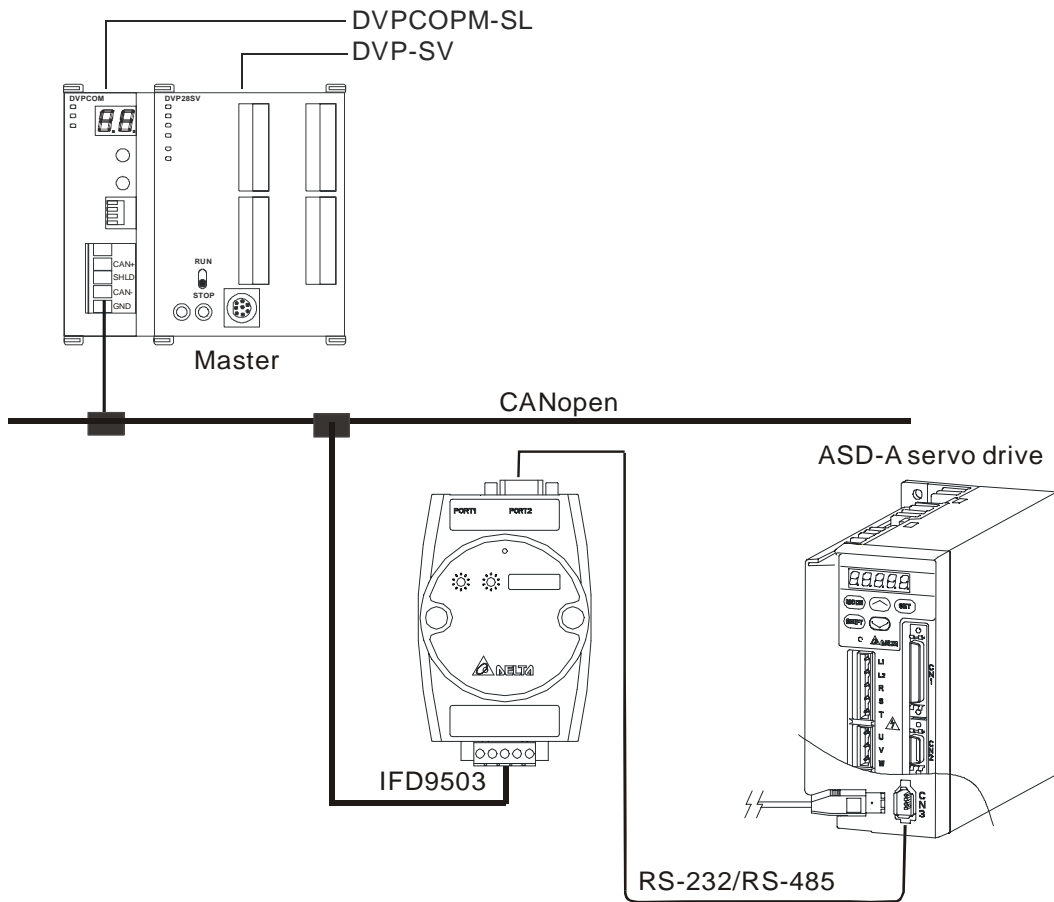

1. Setting up baud rate and communication format

- Before connecting the servo drive to the bus, first set the communication address of the servo drive to 01, baud rate to 115,200bps and communication format to 7, E, 1; ASCII (the format is fixed; other formats will be invalid).
- To adjust the baud rate, follow the steps listed below.
 - Set up the DIP switch SW3 of IFD9503 to custom equipment mode.
 - Connect IFD9503 to the bus of CANopen and enable the operation of IFD9503.
 - Modify the index parameter 5003/05.
 - 5003/05 = 1 → 19,200; 7, E, 1; ASCII
 - 5003/05 = 2 → 38,400; 7, E, 1; ASCII
 - 5003/05 = 3 → 57,600; 7, E, 1; ASCII
 - 5003/05 = 4 → 115,200; 7, E, 1; ASCII (Default)
 - Return SW3 of IFD9503 back to servo drive mode and re-power IFD9503.
 - Adjust the baud rate of the servo drive to the corresponding one.

2. Functions & features

In addition, IFD9503 also supports the following two functions.

- Emergency object – EMERGENCY
 - When IFD9503 detects an internal error, it will send an EMCY message to the CANopen bus.
 - Format
 - IFD9503 → master

COB-ID	Byte 0	Byte 1	Byte 2	Byte 3	Byte 4	Byte 5	Byte 6	Byte 7
128(H'080) +Node-ID	Emergency error code		Error register	00	00	00	00	00
	LSB	MSB						

- Error register

The value in the error register will be mapped to index address H'1001 in the object dictionary. Value = 0 indicates that no error occurs. Value = 1 indicates that a general error takes place. Value = H'80 indicates that an internal error in the equipment occurs.
- Emergency error code
 - ◆ Internal communication error

This error indicates the communication error between IFD9503 and the servo drive (e.g. communication failure). When such error occurs, the emergency error code will be H'8101, and the value in the error register will become 1.
 - ◆ CANopen bus communication error

This error indicates the communication error between CANopen master and IFD9503 slave (e.g. master disconnection). When such error occurs, the emergency error code will be H'8130, and the value in the error register will become 1.
 - ◆ Insufficient length of PDO data

This error indicates that the length of Receive PDO data actually sent out is shorter than the set data length. When such error occurs, the emergency error code will be H'8210, and the value in the error register will become 1.
 - ◆ Internal error in the equipments

This error indicates the error taken place inside the servo drive (e.g. servo drive conducts emergency stop). When such error occurs, the emergency error code will be H'FFXX (XX refers to the error code of the servo drive), and the value in the error register will become H'80.
 - ◆ Eliminating error

When an error is eliminated, the emergency error code will become H'0000.

■ Explanation

Take the COA slave of node ID = 6 as the object and compare the EMERGENCY messages sent out by IFD9503 in different error conditions.

- When in internal communication error

COB-ID	Byte 0	Byte 1	Byte 2	Byte 3	Byte 4	Byte 5	Byte 6	Byte 7
86	01	81	01	00	00	00	00	00

- When in CANopen bus communication error

COB-ID	Byte 0	Byte 1	Byte 2	Byte 3	Byte 4	Byte 5	Byte 6	Byte 7
86	30	81	01	00	00	00	00	00

- When in insufficient PDO data length

COB-ID	Byte 0	Byte 1	Byte 2	Byte 3	Byte 4	Byte 5	Byte 6	Byte 7
86	10	82	01	00	00	00	00	00

- When the servo drive conducts emergency stop (internal error of the equipment)

COB-ID	Byte 0	Byte 1	Byte 2	Byte 3	Byte 4	Byte 5	Byte 6	Byte 7
86	0D	FF	80	00	00	00	00	00

(When stops urgently, the error code of srovo drive is H'0D)

- Error removed

When there is still other error exiting

COB-ID	Byte 0	Byte 1	Byte 2	Byte 3	Byte 4	Byte 5	Byte 6	Byte 7
86	00	00	01	00	00	00	00	00

When all errors have been removed

COB-ID	Byte 0	Byte 1	Byte 2	Byte 3	Byte 4	Byte 5	Byte 6	Byte 7
86	00	00	00	00	00	00	00	00

- Note

Only when error status has changed that IFD9503 could send EMMERGENCY message.

- PDO service

IFD9503 supports PDO1 ~ PDO8. For IFD9503, COB-ID of PDO can be modified but cannot be repeated.

■ PDO1 (Default: Open)

- TxPDO1 (IFD9503 → master):

Send the status data of the slave (IFD9503) to the master. Preset the length of data to be mapped to 2 bytes and the content to be mapped to "status word of digital output contact". You can map any readable parameters, maximum 8 bytes.

Default COB-ID	Byte 0	Byte 1	Byte 2	Byte 3	Byte 4	Byte 5	Byte 6	Byte 7
H'180 + Node-ID	DO1~DO5							

- RxPDO1 (master → IFD9503):

Send the control data of the master to the slave (IFD9503). Preset the length of data to be mapped to 2 bytes and the content to be mapped to "control word of digital input contact". You can map any readable parameters, maximum 8 bytes.

Default COB-ID	Byte 0	Byte 1	Byte 2	Byte 3	Byte 4	Byte 5	Byte 6	Byte 7
H'200 + Node-ID	DI1~DI8							

■ PDO2 ~ PDO8 (Default: Close)

- TxPDO (IFD9503 → master):

Send the status date of the slave (IFD9503) to the master. Preset the length of data to be mapped to 0 byte. You can map any readable parameters, maximum 8 bytes.

Default COB-ID	Byte 0	Byte 1	Byte 2	Byte 3	Byte 4	Byte 5	Byte 6	Byte 7
H'xxxx +Node-ID								

- RxPDO (master→IFD9503):

Send the control data of the master to the slave (IFD9503). Preset the length of data to be

mapped to 0 byte. You can map any readable parameters, maximum 8 bytes.

Default COB-ID	Byte 0	Byte 1	Byte 2	Byte 3	Byte 4	Byte 5	Byte 6	Byte 7
H'yyyy +Node-ID								

■ Data transmission mode

- TxPDO in IFD9503 supports many modes: synchronously non-cyclic, synchronously cyclic, synchronously RTR, asynchronously RTR and asynchronous modes.

3.5 When IFD9503 is connected to programmable logic controller

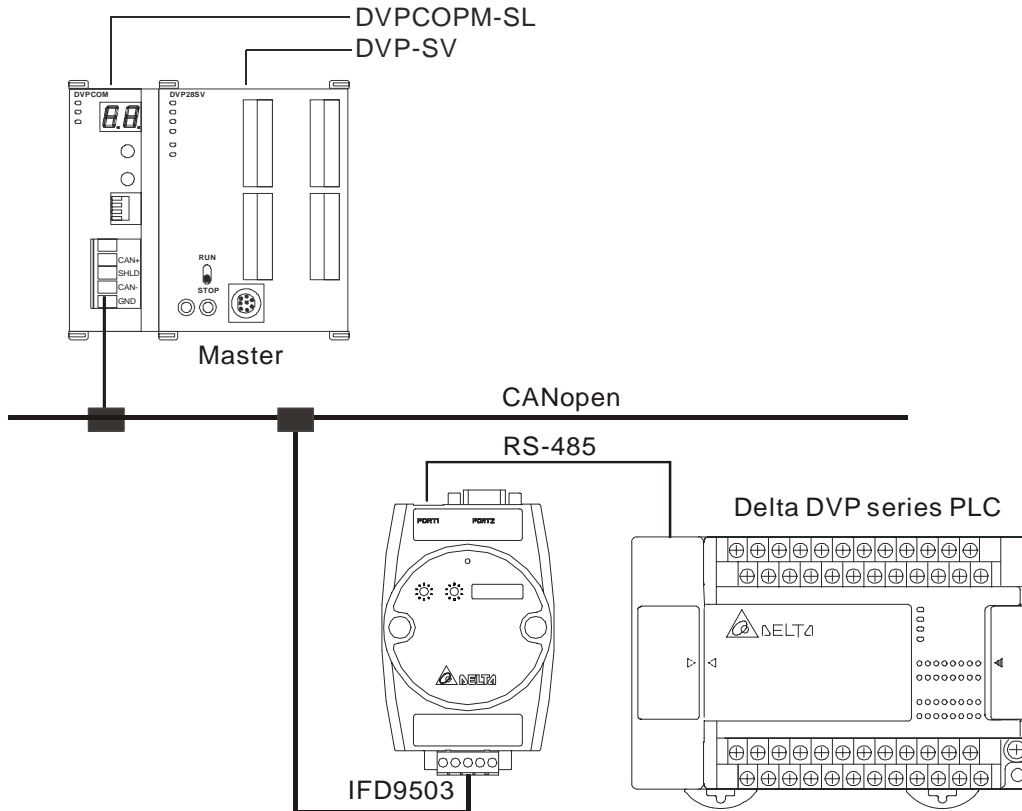

1. Setting up baud rate and communication format

- Before connecting the PLC to the bus, first set up the communication address of the PLC to 01, baud rate to 115,200bps and communication format to 7, E, 1; ASCII (the format is fixed; other formats will be invalid).
- To adjust the baud rate, follow the steps listed below.
 - Set up the DIP switch SW3 of IFD9503 to custom equipment mode.
 - Connect IFD9503 to the bus of CANopen and enable the operation of IFD9503.
 - Modify the index parameter 5003/03
 - 5003/03 = 1 → 19,200; 7, E, 1; ASCII
 - 5003/03 = 2 → 38,400; 7, E, 1; ASCII
 - 5003/03 = 3 → 57,600; 7, E, 1; ASCII
 - 5003/03 = 4 → 115,200; 7, E, 1; ASCII (Default)
 - Return SW3 of IFD9503 back to PLC mode and re-power IFD9503.
 - Adjust the baud rate of the PLC to the corresponding one.

2. Functions & features

In addition, IFD9503 also supports the following two functions.

- Emergency object – EMERGENCY

When IFD9503 detects an internal error, it will send an EMCY message to the CANopen bus.

■ Format

IFD9503 → master

COB-ID	Byte 0	Byte 1	Byte 2	Byte 3	Byte 4	Byte 5	Byte 6	Byte 7
128(H'080) +Node-ID	Emergency error code		Error register	00	00	00	00	00
	LSB	MSB						

- Error register

The value in the error register will be mapped to index address H'1001 in the object dictionary. Value = 0 indicates that no error occurs. Value = 1 indicates that a general error takes place. Value = H'80 indicates that an internal error in the equipment occurs.

- Emergency error code

- ◆ Internal communication error

This error indicates the communication error between IFD9503 and PLC (e.g. communication failure). When such error occurs, the emergency error code will be H'8101, and the value in the error register will become 1.

- ◆ CANopen bus communication error

This error indicates the communication error between CANopen master and IFD9503 slave (e.g. master disconnection). When such error occurs, the emergency error code will be H'8130, and the value in the error register will become 1.

- ◆ Insufficient length of PDO data

This error indicates that the length of Receive PDO data actually sent out is shorter than the set data length. When such error occurs, the emergency error code will be H'8210, and the value in the error register will become 1.

- ◆ Eliminating error

When an error is eliminated, the emergency error code will become H'0000.

■ Explanation

Take the IFD9503 slave of node ID = 6 as the object and compare the EMERGENCY messages sent out by IFD9503 in different error conditions.

- When in internal communication error

COB-ID	Byte 0	Byte 1	Byte 2	Byte 3	Byte 4	Byte 5	Byte 6	Byte 7
86	01	81	01	00	00	00	00	00

- When in CANopen bus communication error

COB-ID	Byte 0	Byte 1	Byte 2	Byte 3	Byte 4	Byte 5	Byte 6	Byte 7
86	30	81	01	00	00	00	00	00

- When in insufficient PDO data length

COB-ID	Byte 0	Byte 1	Byte 2	Byte 3	Byte 4	Byte 5	Byte 6	Byte 7
86	10	82	01	00	00	00	00	00

- When the error is eliminated.

Still other errors exiting:

COB-ID	Byte 0	Byte 1	Byte 2	Byte 3	Byte 4	Byte 5	Byte 6	Byte 7
86	00	00	01	00	00	00	00	00

All errors are eliminated:

COB-ID	Byte 0	Byte 1	Byte 2	Byte 3	Byte 4	Byte 5	Byte 6	Byte 7
86	00	00	00	00	00	00	00	00

- Note

IFD9503 sends out EMMERGENCY message only when error occurs.

- PDO service

IFD9503 supports PDO1 ~ PDO8. For IFD9503, COB-ID of PDO can be modified but cannot be repeated.

- Particularly for PLC, the PDO parameters in IFD9503 are divided into an upload area and download area, featuring:

- TxPDO

TxPDO is only able to map parameter D (upload start address+0) ~ D (upload start address+31), the 32 registers, in the upload area. By modifying the upload start address, you can obtain different upload areas. For example,

When the upload start address = 0, the upload area will be D0 ~ D31.

When the upload start address = 10, the upload area will be D10 ~ D41.

- RxPDO

RxPDO is only able to map parameter D (download start address+0) ~ D (download start address+31), the 32 registers, in the download area. By modifying the download start address, you can obtain different download areas. For example,

When the download start address = 0, the download area will be D0 ~ D31.

When the download start address = 10, the download area will be D10 ~ D41.

- Note: See 13.5.1 "Communication Objects in Object Dictionary" for the corresponding index and sub-index of upload start address, download start address and all mapping parameters.

- PDO1 (Default: Open)

- TxPDO1 (IFD9503 → master):

Send the status data of the slave (IFD9503) to the master. Preset the length of data to be mapped to 8 bytes and the content to be mapped to "the 1st ~ 4th registers in the upload area". You can map any parameters in the upload area, maximum 8 bytes.

Default COB-ID	Byte 0	Byte 1	Byte 2	Byte 3	Byte 4	Byte 5	Byte 6	Byte 7
H'180 + Node-ID	D (up+0)		D (up+1)		D (up+2)		D (up+3)	

- RxPDO1 (master → IFD9503):

Send the control data of the master to the slave (IFD9503). Preset the length of the data to be mapped to 8 bytes and the content to be mapped to “the 1st ~ 4th registers in the download area”. You can map any parameters in the download area, maximum 8 bytes.

Default COB-ID	Byte 0	Byte 1	Byte 2	Byte 3	Byte 4	Byte 5	Byte 6	Byte 7
H'200 + Node-ID	D (down +0)		D (down +1)		D (down +2)		D (down +3)	

■ PDO2 ~ PDO8 (Default: Close)

- TxPDO (IFD9503 → master):

Send the status data of the slave (IFD9503) to the master. Preset the length of the data to be mapped to 0 byte. You can map any parameters in the upload area, maximum 8 bytes.

Default COB-ID	Byte 0	Byte 1	Byte 2	Byte 3	Byte 4	Byte 5	Byte 6	Byte 7
H'xxx +Node-ID								

- RxPDO (master → IFD9503):

Send the control data of the master to the slave (IFD9503). Preset the length of data to be mapped to 0 byte. You can map any parameters in the download area, maximum 8 bytes.

Default COB-ID	Byte 0	Byte 1	Byte 2	Byte 3	Byte 4	Byte 5	Byte 6	Byte 7
H'yyy +Node-ID								

■ Data transmission mode

- TxPDO in IFD9503 supports many modes: synchronous non-cyclic, synchronous cyclic, synchronous RTR, asynchronous RTR and asynchronous modes.

3.6 When IFD9503 is connected to Delta DOP-A HMI

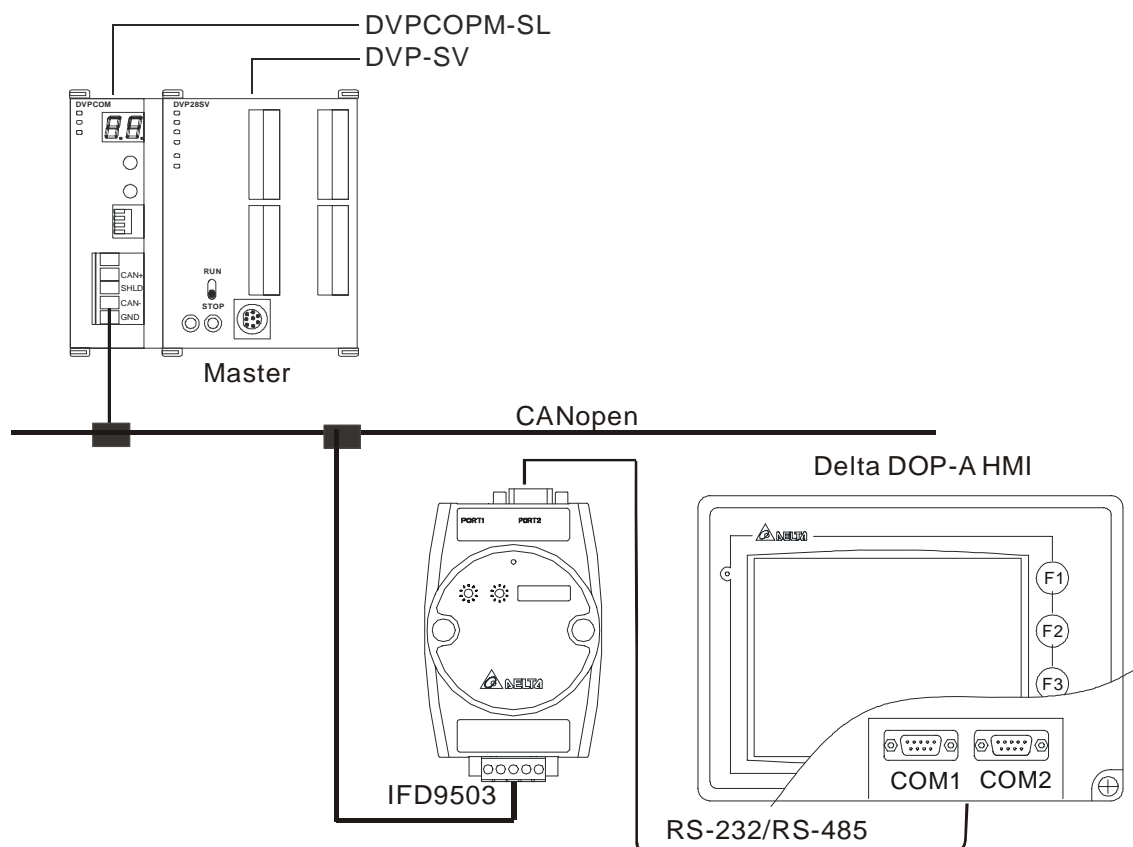

1. Setting up baud rate and communication format

- Before connecting the HMI to the bus, first set up the baud rate to 115,200bps and communication format to 7, E, 1; ASCII (the format is fixed; other formats will be invalid).
- HMI as the master and IFD9503 as the slave. There are 64 virtual D devices (D0 ~ D63) in IFD9503. CANopen master and HMI are able to map, read and write the virtual D devices in IFD9503.
- To adjust the baud rate, follow the steps listed below.
 - Set up the DIP switch SW3 of IFD9503 to custom equipment mode.
 - Connect IFD9503 to the bus of CANopen and enable the operation of IFD9503.
 - Modify the index parameter 5003/06.
 - 5003/06 = 1 → 19,200; 7, E, 1; ASCII
 - 5003/06 = 2 → 38,400; 7, E, 1; ASCII
 - 5003/06 = 3 → 57,600; 7, E, 1; ASCII
 - 5003/06 = 4 → 115,200; 7, E, 1; ASCII (Default)
 - Return SW3 of IFD9503 back to HMI mode and re-power IFD9503.
 - Adjust the baud rate of the HMI to the corresponding one.
- When IFD9503 is connected to DOP HMI, set up the baud rate and communication format following the steps below.

- Open Screen Editor and select “File => New”. You will see the dialog box below.

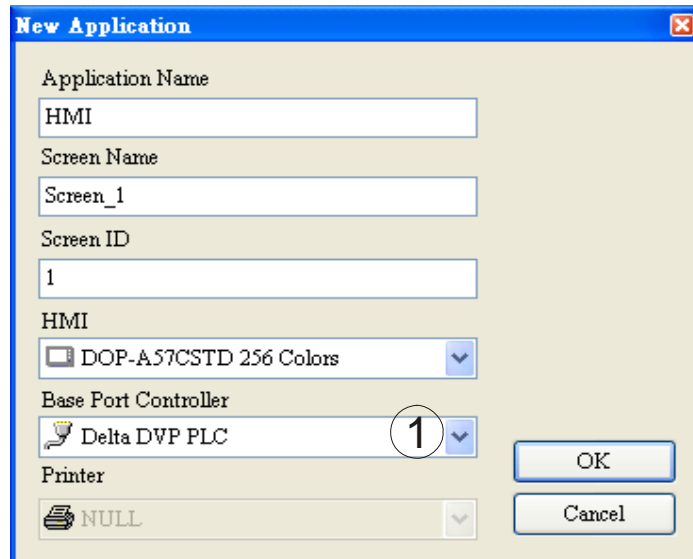

- Select “Delta DVP PLC” to be the Base Port Controller, as step ①. Click “OK” to create a new file.
- Select “Options => Configuration => Communication”, and you will see the dialog box below.

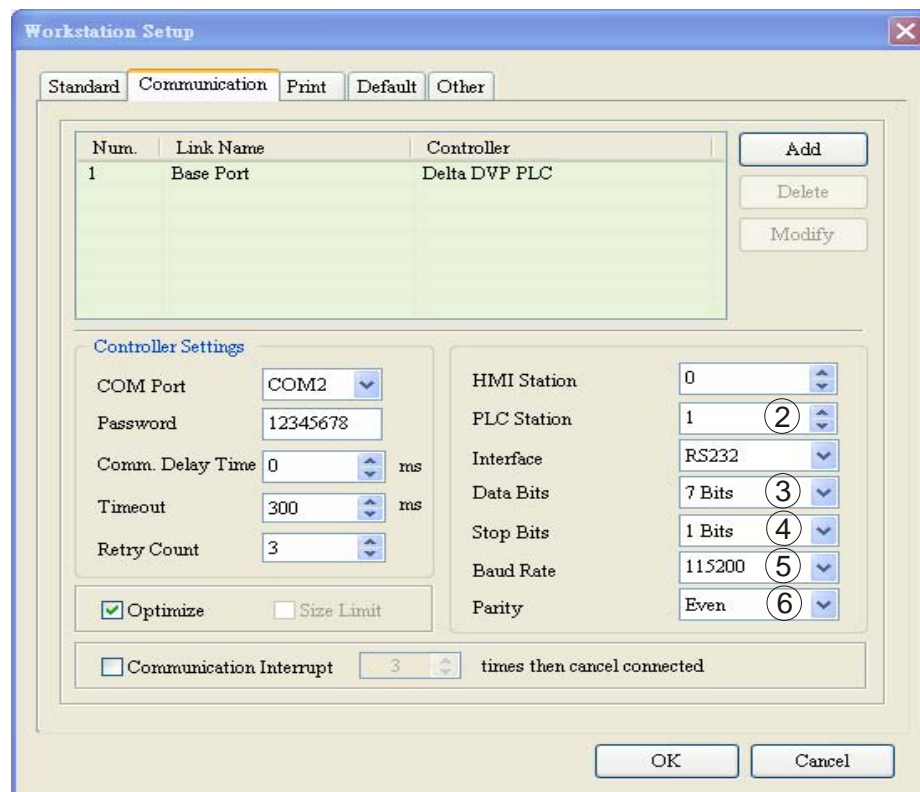

- Follow step ② ~ ⑥: PLC Station = 1; communication format = 115,200, 7, E, 1, ASCII. Click "OK".
- When the HMI connected to DNA02 is TP04/TP02, and then please set up its communication speed and format following the procedure listed below.
 - Open TPEditor and select “File => New”. You will see the dialog box below.

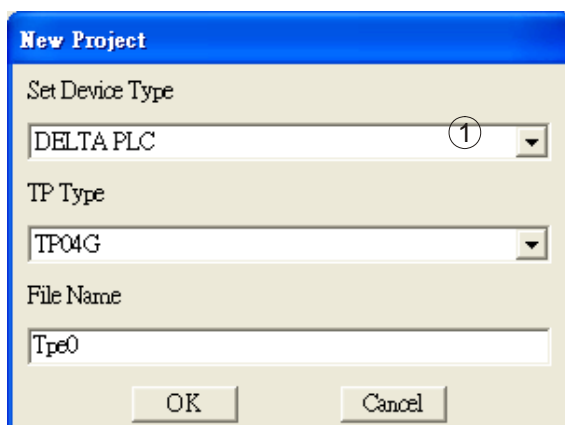

- Select “DELTA PLC” in Set Device Type column, as step ①. Click “OK” to create a new file.
- Select “Tools => TP Object Communication Default Setting”, and you will see the dialog box below.

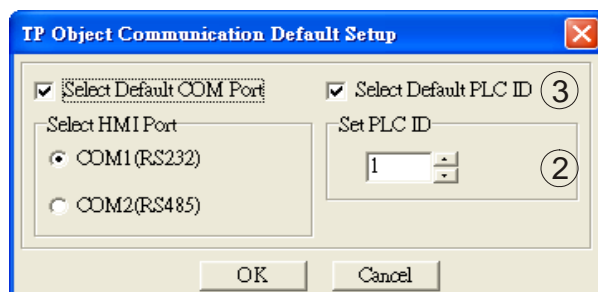

- Follow step ② ~ ③: Set PLC ID = 1; check “Select Default PLC ID”. Click “OK”.

2. Functions & features

In addition, IFD9503 also supports the following two functions.

- Emergency object – EMERGENCY

When IFD9503 detects an internal error, it will send an EMCY message to the CANopen bus.

- Format

IFD9503 → master

COB-ID	Byte 0	Byte 1	Byte 2	Byte 3	Byte 4	Byte 5	Byte 6	Byte 7
128(H'080) +Node-ID	Emergency error code		Error register	00	00	00	00	00
	LSB	MSB						

- Error register

The value in the error register will be mapped to index address H'1001 in the object dictionary. Value = 0 indicates that no error occurs. Value = 1 indicates that a general error takes place. Value = H'80 indicates that an internal error in the equipment occurs.

- Emergency error code

- ◆ CANopen bus communication error

This error indicates the communication error between CANopen master and IFD9503 slave (e.g. master disconnection). When such error occurs, the emergency error code will be H'8130, and the value in the error register will become 1.

- ◆ Insufficient length of PDO data

This error indicates that the length of Receive PDO data actually sent out is shorter than

the set data length. When such error occurs, the emergency error code will be H'8210, and the value in the error register will become 1.

◆ Eliminating error

When an error is eliminated, the emergency error code will become H'0000.

■ Explanation

Take the IFD9503 slave of node ID = 6 as the object and compare the EMERGENCY messages sent out by IFD9503 in different error conditions.

• When in CANopen bus communication error

COB-ID	Byte 0	Byte 1	Byte 2	Byte 3	Byte 4	Byte 5	Byte 6	Byte 7
86	30	81	01	00	00	00	00	00

• When in insufficient PDO data length

COB-ID	Byte 0	Byte 1	Byte 2	Byte 3	Byte 4	Byte 5	Byte 6	Byte 7
86	10	82	01	00	00	00	00	00

• When the error is eliminated

Still other errors exiting:

COB-ID	Byte 0	Byte 1	Byte 2	Byte 3	Byte 4	Byte 5	Byte 6	Byte 7
86	00	00	01	00	00	00	00	00

All errors are eliminated:

COB-ID	Byte 0	Byte 1	Byte 2	Byte 3	Byte 4	Byte 5	Byte 6	Byte 7
86	00	00	00	00	00	00	00	00

• Note:

IFD9503 sends out EMERGENCY message only when error occurs.

• PDO service

IFD9503 supports PDO1 ~ PDO8. For IFD9503, COB-ID of PDO can be modified but cannot be repeated..

■ Particularly for PLC, the PDO parameters in IFD9503 are divided into an upload area and download area, featuring:

• TxPDO

TxPDO is only able to map 32 registers, D32 ~ D63 in the upload area.

• RxPDO

RxPDO is only able to map 32 registers, D32 ~ D63 in the download area.

■ PDO1 (Default: Open)

• TxPDO1 (IFD9503 → master):

Send the status data of the slave (IFD9503) to the master. Preset the length of data to be mapped to 8 bytes and the content to be mapped to “the 1st ~ 4th registers in the upload area”. You can map any parameters in the upload area, maximum 8 bytes.

Default COB-ID	Byte 0	Byte 1	Byte 2	Byte 3	Byte 4	Byte 5	Byte 6	Byte 7
H'180 + Node-ID	D32		D33		D34		D35	

Note: See 13.5.1 “Communication Objects in Object Dictionary” for the corresponding index and sub-index of upload start address, download start address and all mapping parameters.

- RxPDO1 (master → IFD9503):

Send the control data of the master to the slave (IFD9503). Preset the length of data to be mapped to 8 bytes and the content to be mapped to “the 1st ~ 4th registers in the download area”. You can map any parameters in the download area, maximum 8 bytes.

Default COB-ID	Byte 0	Byte 1	Byte 2	Byte 3	Byte 4	Byte 5	Byte 6	Byte 7
H'200 + Node-ID	D0		D1		D2		D3	

- PDO2 ~ PDO8 (Default: Close)

- TxPDO (IFD9503 → master):

Send the status data of the slave (IFD9503) to the master. Preset the length of the data to be mapped to 0 byte. You can map any parameters in the download area, maximum 8 bytes.

Default COB-ID	Byte 0	Byte 1	Byte 2	Byte 3	Byte 4	Byte 5	Byte 6	Byte 7
H'xxx +Node-ID								

- RxPDO (master → IFD9503):

Send the control data of the master to the slave equipment (IFD9503). Preset the length of the data to be mapped to 0 byte. You can map any parameters in the download area, maximum 8 bytes.

Default COB-ID	Byte 0	Byte 1	Byte 2	Byte 3	Byte 4	Byte 5	Byte 6	Byte 7
H'yyy +Node-ID								

- Data transmission mode

TxPDO in IFD9503 supports many modes: synchronously non-cyclic, synchronously cyclic, synchronous RTR, asynchronous RTR and asynchronous modes.

3.7 When IFD9503 is connected to custom equipment

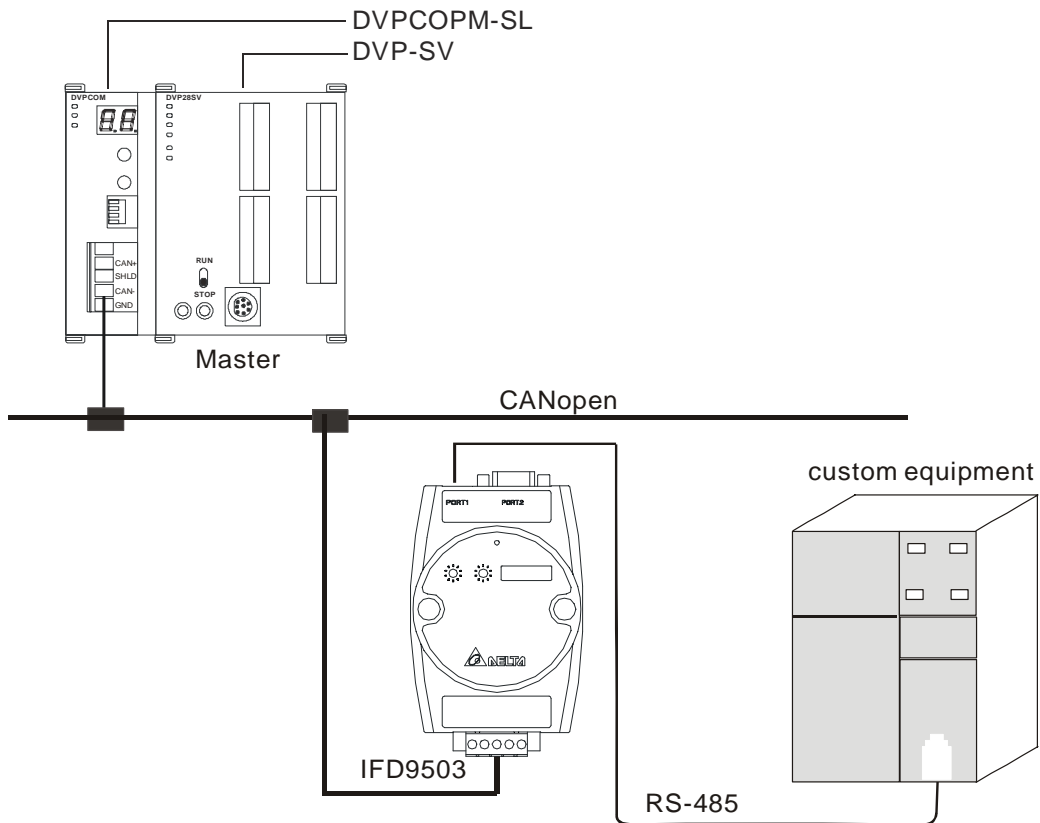

1. Setting up baud rate and communication format

- Before connecting the custom equipment to the bus, first set up the communication address of the equipment to 01, baud rate to 19,200bps and communication format to 8, N, 2; RTU (the format is fixed; other formats will be invalid).
- To adjust the baud rate, follow the steps listed below.
 - Modify the index parameter 5003/07.
 - 5003/07 = 1 → 19,200; 8, N, 2; RTU (Default)
 - 5003/07 = 2 → 38,400; 8, N, 2; RTU
 - 5003/07 = 3 → 57,600; 8, N, 2; RTU
 - 5003/07 = 4 → 115,200; 8, N, 2; RTU
 - Re-power IFD9503 and adjust the baud rate of the custom equipment to the corresponding one. Note: When IFD9503 is connected to custom equipment, IFD9503 will enter the pre-run status automatically after it is powered in any configuration, which allows you to adjust the baud rate and so on in that mode.

2. Functions & features

In addition, IFD9503 also supports the following two functions.

- Emergency object – EMERGENCY
 - When IFD9503 detects an internal error, it will send an EMCY message to the CANopen bus.
 - Format
 - IFD9503 → master

COB-ID	Byte 0	Byte 1	Byte 2	Byte 3	Byte 4	Byte 5	Byte 6	Byte 7
128(H'080) +Node-ID	Emergency error code		Error register	00	00	00	00	00
	LSB	MSB						

- Error register
The value in the error register will be mapped to index address H'1001 in the object dictionary. Value = 0 indicates that no error occurs. Value = 1, it indicates that a general error takes place. Value = H'80 indicates that an internal error in the equipment occurs.
- Emergency error code
 - ◆ CANopen bus communication error
This error indicates the communication error between CANopen master and IFD9503 slave (e.g. master disconnection). When such error occurs, the emergency error code will be H'8130, and the value in the error register will become 1.
 - ◆ Insufficient length of PDO data
This error indicates that the length of Receive PDO data actually sent out is shorter than the set data length. When such error occurs, the emergency error code will be H'8210, and the value in the error register will become 1.
 - ◆ Eliminating error
When an error is eliminated, the emergency error code will become H'0000.

■ Explanation

Take the IFD9503 slave of node ID = 6 as the object and compare the EMERGENCY messages sent out by IFD9503 in different error conditions.

- When in CANopen bus communication error

COB-ID	Byte 0	Byte 1	Byte 2	Byte 3	Byte 4	Byte 5	Byte 6	Byte 7
86	30	81	01	00	00	00	00	00

- When in insufficient PDO data length

COB-ID	Byte 0	Byte 1	Byte 2	Byte 3	Byte 4	Byte 5	Byte 6	Byte 7
86	10	82	01	00	00	00	00	00

- When the error is eliminated.

Still other errors exiting:

COB-ID	Byte 0	Byte 1	Byte 2	Byte 3	Byte 4	Byte 5	Byte 6	Byte 7
86	00	00	01	00	00	00	00	00

All errors are eliminated:

COB-ID	Byte 0	Byte 1	Byte 2	Byte 3	Byte 4	Byte 5	Byte 6	Byte 7
86	00	00	00	00	00	00	00	00

- Note:

IFD9503 sends out EMERGENCY message only when error occurs.

- PDO service

IFD9503 supports PDO1 ~ PDO8. For IFD9503, COB-ID of PDO can be modified but cannot be

repeated.

- Particularly for custom equipment, the PDO parameters in IFD9503 are divided into an upload area and download area, featuring:

- TxPDO

TxPDO is only able to map 32 parameters (sub-index address) in the upload area (index H'5001). For example,

5001/01 (1st word of TxPDO1)

5001/02 (2nd word of TxPDO1)

If you would like to correspond the 1st word of TxPDO1 to a certain Modbus address (parameter address) of the connected equipment, you can write the Modbus address into 5001/01. The same rule also applies to other sub-index addresses.

- RxPDO

RxPDO is only able to map 32 parameters (sub-index address) in the download area (index H'5000). For example,

5000/01 (1st word of RxPDO1)

5000/02 (2nd word of RxPDO1)

If you would like to correspond the 1st word of RxPDO1 to a certain Modbus address (parameter address) of the connected equipment, you can write the Modbus address into 5000/01. The same rule also applies to other sub-index addresses.

- Note: See 13.5.1 “Communication Objects in Object Dictionary” for the corresponding index and sub-index of upload start address, download start address and all mapping parameters.

- PDO1 (Default: Open)

- TxPDO1 (IFD9503 → master):

Send the status data of the slave (IFD9503) to the master. Preset the length of data to be mapped to 0 byte. You can map maximum 8 bytes in the 1st word of TxPDO 1 ~ 4th word of TxPDO1 in the upload area. The mapping relation is corresponding and fixed. For example,

Word 1 (byte 0 & byte 1) → 1st word of TxPDO1

Word 2 (byte 2 & byte 3) → 2nd word of TxPDO1

Word 3 (byte 4 & byte 5) → 3rd word of TxPDO1

Word 4 (byte 6 & byte 7) → 4th word of TxPDO1

Default COB-ID	Byte 0	Byte 1	Byte 2	Byte 3	Byte 4	Byte 5	Byte 6	Byte 7
H'180 + Node-ID								

- RxPDO1 (master → IFD9503):

Send the control data of the master to the slave (IFD9503). Preset the length of the data to be mapped to 0 byte. You can map maximum 8 bytes in the 1st word of RxPDO 1 ~ 4th word of RxPDO1 in the download area. The mapping relation is corresponding and fixed. For example,

Word 1 (byte 0 & byte 1) → 1st word of RxPDO1;

Word 2 (byte 2 & byte 3) → 2nd word of RxPDO1

Word 3 (byte 4 & byte 5) → 3rd word of RxPDO1

Word 4 (byte 6 & byte 7) → 4th word of RxPDO1

Default COB-ID	Byte 0	Byte 1	Byte 2	Byte 3	Byte 4	Byte 5	Byte 6	Byte 7
H'200 + Node-ID								

■ PDO2 ~ PDO8 (Default: Close)

- TxPDO (IFD9503 → master):

Send the status data of the slave equipment (IFD9503) to the master. Preset the length of the data to be mapped to 0 byte. You can map maximum 8 bytes. Same as TxPDO1, PDO2 ~ PDO8 map RxPDO2 ~ RxPDO8. The mapping relation is corresponding and fixed.

Default COB-ID	Byte 0	Byte 1	Byte 2	Byte 3	Byte 4	Byte 5	Byte 6	Byte 7
H'xxxx +Node-ID								

- RxPDO (master → IFD9503):

Send the control data of the master to the slave (IFD9503). Preset the length of the data to be mapped to 0 byte. You can map maximum 8 bytes. Same as RxPDO1, PDO2 ~ PDO8 map RxPDO2 ~ RxPDO8 in the download area. The mapping relation is corresponding and fixed.

Default COB-ID	Byte 0	Byte 1	Byte 2	Byte 3	Byte 4	Byte 5	Byte 6	Byte 7
H'yyyy +Node-ID								

■ Explanation

If the custom equipment is a Delta VFD-B AC motor drive, and we would like to control its RUN/STOP, frequency input and monitor its operation status and frequency, follow the explanations below:

- Map the 1st word of RxPDO1 and 2nd word of RxPDO1 in RxPDO1 and map the 1st word of TxPDO1 and 2nd word of TxPDO1 in TxPDO1.
- Write the Modbus address corresponding to VFD-B in the index address of IFD9503 through SDO, e.g. H'2000 → 5000/01, H'2001 → 5000/02; H'2101 → 5001/01, H'2103 → 5001/02.
- In this way, we will be able to control the control word (H'2000), frequency command (H'2001) and monitor the status word (H'2101) and running frequency (H'2103) in VFD-B through RxPDO1 and TxPDO1.
- Note: You can only map the Modbus address of 16-bit word device in the download area and upload area.

■ Data transmission mode

- TxPDO in IFD9503 supports many modes: synchronously non-cyclic, synchronously cyclic, synchronous RTR, asynchronous RTR and asynchronous modes.

4 LED Indicators & Trouble-shooting

There are 3 LED indicators on IFD9503, RUN, ERROR and SCAN, for displaying the connection status of the communication in IFD9503.

4.1 RUN LED

LED Status	IFD9503 Status	How to deal with it
Off	No power	Check the power of IFD9503 and make sure the connection is normal.
Green light 1 flash	Stop	
Green light flashes	Pre-operation	
Green light On	Operating	
Red light On	NODE-ID error	Check if the setting of NODE-ID of IFD9503 is correct.

4.2 ERROR LED

LED Status	IFD9503 Status	How to deal with it
Off	No error	IFD9503 operation is normal.
Red light 2 flashes	Erroneous control occurs.	1. Check if the connection between IFD9503 and the master station is intact. 2. Check if the communication between IFD9503 and the master station is normal.
Red light On	bus OFF	1. Check if the bus connection is normal. 2. Re-power IFD9503.

4.3 SCAN LED

LED Status	IFD9503 Status	How to deal with it
Off	No power	Check the power of IFD9503 and make sure the connection is normal.
Green light flashes	The correct information of the equipment connected has not been detected.	Re-connect IFD9503 to the equipment.
Green light On	The communication with the equipment connected is normal.	
Red light flashes	CRC check fails	1. Check if the communication cable between IFD9503 and the equipment is correct. 2. Check if there is electromagnetic interference nearby.
Red light On	Connection fails, or no connection	1. Check if the communication format of the equipment is correct. 2. Check if IFD9503 and the equipment are correctly connected. 3. Restart the connection and make sure the communication cable meets the specification.

5 Object Dictionary

1. Communication objects in the object dictionary:

Index	Sub-index	Object name	Data type	Access authorization	Default
H'1000	H'00	Equipment type	Unsigned 32 bits	R	0x00000000
H'1001	H'00	Error register	Unsigned 8 bits	R	0
H'1003		Predefined error field			
	H'00	Number of errors	Unsigned 8 bits	R	0
	H'01	Standard error field	Unsigned 32 bits	R	0

Index	Sub-index	Object name	Data type	Access authorization	Default
H'1005	H'00	COB-ID SYNC message	Unsigned 32 bits	RW	0x00000080
H'1008	H'00	Equipment name of supplier	Visible character string	R	IFD9503
H'100C	H'00	Protection time	Unsigned 16 bits	RW	0
H'100D	H'00	Life time factor	Unsigned 8 bits	RW	0
H'1014	H'00	COB-ID emergency message	Unsigned 32 bits	R	0x80 + Node-ID
H'1016		Pulsant time of the user			
	H'00	Number of items	Unsigned 8 bits	R	1
	H'01	Pulsant time of the user	Unsigned 32 bits	RW	0
H'1017	H'00	Pulsant time of generator	Unsigned 16 bits	RW	0
H'1018		Identification object			
	H'00	Number of items	Unsigned 8 bits	R	3
	H'01	Supplier code	Unsigned 32 bits	R	0x000001DD
	H'02	Product code	Unsigned 32 bits	R	Depends on the connected equipment
	H'03	Version	Unsigned 32 bits	R	0x00010002
H'1400		RxPDO1 communication parameter			
	H'00	Number of items	Unsigned 8 bits	R	3
	H'01	COB-ID of RxPDO1	Unsigned 32 bits	RW	0x00000200+Node-ID
	H'02	Transmission mode	Unsigned 8 bits	RW	0xFF
	H'03	Forbidden time	Unsigned 16 bits	RW	0
H'1401		RxPDO2 communication parameter			
	H'00	Number of items	Unsigned 8 bits	R	3
	H'01	COB-ID of RxPDO2	Unsigned 32 bits	RW	0x80000000
	H'02	Transmission mode	Unsigned 8 bits	RW	0xFF
	H'03	Forbidden time	Unsigned 16 bits	RW	0
H'1402		RxPDO3 communication parameter			
	H'00	Number of items	Unsigned 8 bits	R	3
	H'01	COB-ID of RxPDO3	Unsigned 32 bits	RW	0x80000000
	H'02	Transmission mode	Unsigned 8 bits	RW	0xFF
	H'03	Forbidden time	Unsigned 16 bits	RW	0
H'1403		RxPDO4 communication parameter			
	H'00	Number of items	Unsigned 8 bits	R	3
	H'01	COB-ID of RxPDO4	Unsigned 32 bits	RW	0x80000000
	H'02	Transmission mode	Unsigned 8 bits	RW	0xFF
	H'03	Forbidden time	Unsigned 16 bits	RW	0
H'1404		RxPDO5 communication parameter			
	H'00	Number of items	Unsigned 8 bits	R	3
	H'01	COB-ID of RxPDO5	Unsigned 32 bits	RW	0x80000000

Index	Sub-index	Object name	Data type	Access authorization	Default
	H'02	Transmission mode	Unsigned 8 bits	RW	0xFF
	H'03	Forbidden time	Unsigned 16 bits	RW	0
H'1405		RxPDO6 communication parameter			
	H'00	Number of items	Unsigned 8 bits	R	3
	H'01	COB-ID of RxPDO6	Unsigned 32 bits	RW	0x80000000
	H'02	Transmission mode	Unsigned 8 bits	RW	0xFF
	H'03	Forbidden time	Unsigned 16 bits	RW	0
H'1406		RxPDO7 communication parameter			
	H'00	Number of items	Unsigned 8 bits	R	3
	H'01	COB-ID of RxPDO7	Unsigned 32 bits	RW	0x80000000
	H'02	Transmission mode	Unsigned 8 bits	RW	0xFF
	H'03	Forbidden time	Unsigned 16 bits	RW	0
H'1407		RxPDO8 communication parameter			
	H'00	Number of items	Unsigned 8 bits	R	3
	H'01	COB-ID of RxPDO8	Unsigned 32 bits	RW	0x80000000
	H'02	Transmission mode	Unsigned 8 bits	RW	0xFF
	H'03	Forbidden time	Unsigned 16 bits	RW	0
H'1600		RxPDO1 mapping parameter			
	H'00	Number of items	Unsigned 8 bits	RW	Depends on the connected equipment
	H'01	The first mapped object	Unsigned 32 bits	RW	Depends on the connected equipment
	H'01	The second mapped object	Unsigned 32 bits	RW	Depends on the connected equipment
	H'02	The third mapped object	Unsigned 32 bits	RW	Depends on the connected equipment
	H'03	The fourth mapped object	Unsigned 32 bits	RW	Depends on the connected equipment
H'1601		RxPDO2 mapping parameter			
	H'00	Number of items	Unsigned 8 bits	RW	0
	H'01	The first mapped object	Unsigned 32 bits	RW	0
	H'01	The second mapped object	Unsigned 32 bits	RW	0
	H'02	The third mapped object	Unsigned 32 bits	RW	0
	H'03	The fourth mapped object	Unsigned 32 bits	RW	0
H'1602		RxPDO3 mapping parameter			
	H'00	Number of items	Unsigned 8 bits	RW	0
	H'01	The first mapped object	Unsigned 32 bits	RW	0
	H'01	The second mapped object	Unsigned 32 bits	RW	0
	H'02	The third mapped object	Unsigned 32 bits	RW	0
	H'03	The fourth mapped object	Unsigned 32 bits	RW	0
H'1603		RxPDO4 mapping parameter			
	H'00	Number of items	Unsigned 8 bits	RW	0

Index	Sub-index	Object name	Data type	Access authorization	Default
	H'01	The first mapped object	Unsigned 32 bits	RW	0
	H'01	The sencond mapped object	Unsigned 32 bits	RW	0
	H'02	The third mapped object	Unsigned 32 bits	RW	0
	H'03	The fourth mapped object	Unsigned 32 bits	RW	0
H'1604		RxPDO5 mapping parameter			
	H'00	Number of items	Unsigned 8 bits	RW	0
	H'01	The first mapped object	Unsigned 32 bits	RW	0
	H'01	The sencond mapped object	Unsigned 32 bits	RW	0
	H'02	The third mapped object	Unsigned 32 bits	RW	0
	H'03	The fourth mapped object	Unsigned 32 bits	RW	0
H'1605		RxPDO6 mapping parameter			
	H'00	Number of items	Unsigned 8 bits	RW	0
	H'01	The first mapped object	Unsigned 32 bits	RW	0
	H'01	The sencond mapped object	Unsigned 32 bits	RW	0
	H'02	The third mapped object	Unsigned 32 bits	RW	0
	H'03	The fourth mapped object	Unsigned 32 bits	RW	0
H'1606		RxPDO7 mapping parameter			
	H'00	Number of items	Unsigned 8 bits	RW	0
	H'01	The first mapped object	Unsigned 32 bits	RW	0
	H'01	The sencond mapped object	Unsigned 32 bits	RW	0
	H'02	The third mapped object	Unsigned 32 bits	RW	0
	H'03	The fourth mapped object	Unsigned 32 bits	RW	0
H'1607		RxPDO8 mapping parameter			
	H'00	Number of items	Unsigned 8 bits	RW	0
	H'01	The first mapped object	Unsigned 32 bits	RW	0
	H'01	The sencond mapped object	Unsigned 32 bits	RW	0
	H'02	The third mapped object	Unsigned 32 bits	RW	0
	H'03	The fourth mapped object	Unsigned 32 bits	RW	0
H'1800		TxPDO1 communication parameter			
	H'00	Number of items	Unsigned 8 bits	R	5
	H'01	COB-ID of TxPDO1	Unsigned 32 bits	RW	0x00000180+Node-ID
	H'02	Transmission mode	Unsigned 8 bits	RW	0xFF
	H'03	Forbidden time	Unsigned 16 bits	RW	50
	H'05	Timer	Unsigned 16 bits	RW	100
H'1801		TxPDO2 communication parameter			
	H'00	Number of items	Unsigned 8 bits	R	5
	H'01	COB-ID of TxPDO2	Unsigned 32 bits	RW	0x80000000
	H'02	Transmission mode	Unsigned 8 bits	RW	0xFF
	H'03	Forbidden time	Unsigned 16 bits	RW	50

Index	Sub-index	Object name	Data type	Access authorization	Default
	H'05	Timer	Unsigned 16 bits	RW	100
H'1802		TxPDO3 communication parameter			
	H'00	Number of items	Unsigned 8 bits	R	5
	H'01	COB-ID of TxPDO3	Unsigned 32 bits	RW	0x80000000
	H'02	Transmission mode	Unsigned 8 bits	RW	0xFF
	H'03	Forbidden time	Unsigned 16 bits	RW	50
	H'05	Timer	Unsigned 16 bits	RW	100
H'1803		TxPDO4 communication parameter			
	H'00	Number of items	Unsigned 8 bits	R	5
	H'01	COB-ID of TxPDO4	Unsigned 32 bits	RW	0x80000000
	H'02	Transmission mode	Unsigned 8 bits	RW	0xFF
	H'03	Forbidden time	Unsigned 16 bits	RW	50
	H'05	Timer	Unsigned 16 bits	RW	100
H'1804		TxPDO5 communication parameter			
	H'00	Number of items	Unsigned 8 bits	R	5
	H'01	COB-ID of TxPDO5	Unsigned 32 bits	RW	0x80000000
	H'02	Transmission mode	Unsigned 8 bits	RW	0xFF
	H'03	Forbidden time	Unsigned 16 bits	RW	50
	H'05	Timer	Unsigned 16 bits	RW	100
H'1805		TxPDO6 communication parameter			
	H'00	Number of items	Unsigned 8 bits	R	5
	H'01	COB-ID of TxPDO6	Unsigned 32 bits	RW	0x80000000
	H'02	Transmission mode	Unsigned 8 bits	RW	0xFF
	H'03	Forbidden time	Unsigned 16 bits	RW	50
	H'05	Timer	Unsigned 16 bits	RW	100
H'1806		TxPDO7 communication parameter			
	H'00	Number of items	Unsigned 8 bits	R	5
	H'01	TxPDO7 的 COB-ID	Unsigned 32 bits	RW	0x80000000
	H'02	Transmission mode	Unsigned 8 bits	RW	0xFF
	H'03	Forbidden time	Unsigned 16 bits	RW	50
	H'05	Timer	Unsigned 16 bits	RW	100
H'1807		TxPDO8 communication parameter			
	H'00	Number of items	Unsigned 8 bits	R	5
	H'01	COB-ID of TxPDO8	Unsigned 32 bits	RW	0x80000000
	H'02	Transmission mode	Unsigned 8 bits	RW	0xFF
	H'03	Forbidden time	Unsigned 16 bits	RW	50
	H'05	Timer	Unsigned 16 bits	RW	100
H'1A00		TxPDO1 mapping parameter			

Index	Sub-index	Object name	Data type	Access authorization	Default
	H'00	Number of items	Unsigned 8 bits	RW	Depends on the connected equipment
	H'01	The first mapped object	Unsigned 32 bits	RW	Depends on the connected equipment
	H'02	The second mapped object	Unsigned 32 bits	RW	Depends on the connected equipment
	H'03	The third mapped object	Unsigned 32 bits	RW	Depends on the connected equipment
	H'04	The fourth mapped object	Unsigned 32 bits	RW	Depends on the connected equipment
H'1A01		TxPDO2 mapping parameter			
	H'00	Number of items	Unsigned 8 bits	RW	0
	H'01	The first mapped object	Unsigned 32 bits	RW	0
	H'02	The second mapped object	Unsigned 32 bits	RW	0
	H'03	The third mapped object	Unsigned 32 bits	RW	0
	H'04	The fourth mapped object	Unsigned 32 bits	RW	0
H'1A02		TxPDO3 mapping parameter			
	H'00	Number of items	Unsigned 8 bits	RW	0
	H'01	The first mapped object	Unsigned 32 bits	RW	0
	H'02	The second mapped object	Unsigned 32 bits	RW	0
	H'03	The third mapped object	Unsigned 32 bits	RW	0
	H'04	The fourth mapped object	Unsigned 32 bits	RW	0
H'1A03		TxPDO4			
	H'00	Number of items	Unsigned 8 bits	RW	0
	H'01	The first mapped object	Unsigned 32 bits	RW	0
	H'02	The second mapped object	Unsigned 32 bits	RW	0
	H'03	The third mapped object	Unsigned 32 bits	RW	0
	H'04	The fourth mapped object	Unsigned 32 bits	RW	0
H'1A04		TxPDO5 mapping parameter			
	H'00	Number of items	Unsigned 8 bits	RW	0
	H'01	The first mapped object	Unsigned 32 bits	RW	0
	H'02	The second mapped object	Unsigned 32 bits	RW	0
	H'03	The third mapped object	Unsigned 32 bits	RW	0
	H'04	The fourth mapped object	Unsigned 32 bits	RW	0
H'1A05		TxPDO6 mapping parameter			
	H'00	Number of items	Unsigned 8 bits	RW	0
	H'01	The first mapped object	Unsigned 32 bits	RW	0
	H'02	The second mapped object	Unsigned 32 bits	RW	0
	H'03	The third mapped object	Unsigned 32 bits	RW	0
	H'04	The fourth mapped object	Unsigned 32 bits	RW	0
H'1A06		TxPDO7 mapping parameter			
	H'00	Number of items	Unsigned 8 bits	RW	0
	H'01	The first mapped object	Unsigned 32 bits	RW	0

Index	Sub-index	Object name	Data type	Access authorization	Default
	H'02	The second mapped object	Unsigned 32 bits	RW	0
	H'03	The third mapped object	Unsigned 32 bits	RW	0
	H'04	The fourth mapped object	Unsigned 32 bits	RW	0
H'1A07		TxPDO8 mapping parameter			
	H'00	Number of items	Unsigned 8 bits	RW	0
	H'01	The first mapped object	Unsigned 32 bits	RW	0
	H'02	The second mapped object	Unsigned 32 bits	RW	0
	H'03	The third mapped object	Unsigned 32 bits	RW	0
	H'04	The fourth mapped object	Unsigned 32 bits	RW	0

2. Parameter objects of Delta VFD series AC motor drive in the object dictionary

- Main index: H'2000-----user parameters

Sub-index (hex)	Parameter No.	Parameter function
1	00-00	Identity code of the AC motor drive
2	00-01	Displaying of drive's rated current
3	00-02	Parameter reset
⋮	⋮	⋮
9	00-08	Setting up parameter protection password
A	00-09	Control method
B	00-10	Reserved

- Main index: H'2001-----basic parameters

Sub-index (hex)	Parameter No.	Parameter function
1	01-00	Setting up max. operation parameter frequency
2	01-01	Setting up motor's rated frequency
3	01-02	Setting up motor's rated voltage
⋮	⋮	⋮
16	01-21	Setting up the 4 th deceleration time
17	01-22	Setting up JOG deceleration time
18	01-23	Setting up the unit of acceleration/deceleration time

- Main index: H'2002-----operation method parameters

Sub-index (hex)	Parameter No.	Parameter function
1	02-00	Setting up the source of the 1 st frequency instruction
2	02-01	Setting up the source of the 1 st operation instruction
3	02-02	Selecting the stop method of motor
⋮	⋮	⋮
E	02-13	Setting up the source of the 2 nd frequency instruction
F	02-14	Setting up the source of the 2 nd operation instruction
10	02-15	Keyboard frequency instruction

- Main index: H'2003-----output function parameters

Sub-index (hex)	Parameter No.	Parameter function
1	03-00	Multi-function output relay
2	03-01	Multi-function output MO1
3	03-02	Multi-function output MO2
⋮	⋮	⋮
D	03-12	Fan control
E	03-13	Break release frequency
F	03-14	Break engage frequency

- Main index: H'2004-----input function parameters

Sub-index (hex)	Parameter No.	Parameter function
1	04-00	AUI analog input bias
2	04-01	AUI bias polarity
3	04-02	AUI input gain
⋮	⋮	⋮
18	04-23	Deceleration ratio of deceleration gear
19	04-24	Index angle for simple index function
1A	04-25	Deceleration time for simple index function

- Main index: H'2005-----multi-step speed and PLC parameters

Sub-index (hex)	Parameter No.	Parameter function
1	05-00	Setting up the 1 st step speed frequency
2	05-01	Setting up the 2 nd step speed frequency
3	05-02	Setting up the 3 rd step speed frequency
⋮	⋮	⋮
21	05-32	Setting up the unit of operation time
22	05-33	The amplitude of wobble vibration
23	05-34	Wobble skip frequency

- Main index: H'2006-----protection parameters

Sub-index (hex)	Parameter No.	Parameter function
1	06-00	Over-voltage stall prevention
2	06-01	Over-current stall prevention during accel
3	06-02	Over-current stall prevention during operation
⋮	⋮	⋮
11	06-16	User-defined low-voltage detection level
12	06-17	User-defined low-voltage detection time
13	06-18	Reserved

- Main index: H'2007-----motor parameters

Sub-index (hex)	Parameter No.	Parameter function
1	07-00	Motor rated current

Sub-index (hex)	Parameter No.	Parameter funcion
2	07-01	Motor no-load current
3	07-02	Torque compensation
⋮	⋮	⋮
E	07-13	Slip compensation time constant
F	07-14	Accumulative motor operation time (min)
10	07-15	Accumulative motor operation time (day)

- Main index: H'2008-----special parameters

Sub-index (hex)	Parameter address	Parameter funcion
1	08-00	DC braking current level
2	08-01	DC braking time during start-up
3	08-02	DC braking time during stopping
⋮	⋮	⋮
15	08-20	Speed search frequncy during start-up
16	08-21	Auto reset time at restart after fault
17	08-22	Compensation coefficient for motor instability

- Main index: H'2009----- communication parameters

Sub-index (hex)	Parameter No.	Parameter funcion
1	09-00	Communication address
2	09-01	Transmission speed
3	09-02	Transmission fault treatment
4	09-03	Time-out detection
5	09-04	Communication protocol
6	09-05	Reserved
7	09-06	Reserved
8	09-07	Response delay time

- Main index: H'200A-----PID control parameters

Sub-index (hex)	Parameter No.	Parameter funcion
1	10-00	Selecting PID feedback input terminal
2	10-01	Gain over the PID detection value
3	10-02	Proportional gain (P)
⋮	⋮	⋮
F	10-14	PG slip compensation limit
10	10-15	PG output sampling time
11	10-16	PID offset level

- Main index: H'200B-----multiple motors control parameters

Sub-index (hex)	Parameter No.	Parameter funcion
1	11-00	Selecting V/f curve

Sub-index (hex)	Parameter No.	Parameter function
2	11-01	Start-up frequency of the auxiliary motor
3	11-02	Stop frequency of the auxiliary motor
4	11-03	Delay time before starting the auxiliary motor
5	11-04	Delay time before stopping the auxiliary motor
6	11-05	Sleep/wake up detection time
7	11-06	Sleep frequency
8	11-07	Wake-up frequency

- Main index: H'2020-----communication control parameters

Sub-index (hex)	Parameter address	Parameter function
1	H'2000	Control instruction
2	H'2001	Frecqncy instruction
3	H'2002	E. F. On / Reset instruction

- Main index: H'2021-----communication status parameters

Sub-index (hex)	Parameter address	Parameter function
1	H'2100	Error code
2	H'2101	Status word
3	H'2102	Frequency instruction
⋮	⋮	⋮
F	H'210E	Number of PG pulses within unit time (high)
10	H'210F	Output frequency (KW)
11	H'2110	Reserved

- Main index: H'2022-----communication status parameters

Sub-index (hex)	Parameter address	Parameter function
1	H'2200	Feadback signal (XXX.XX%)
2	H'2201	Defined by user (low word)
3	H'2202	Defined by user (high word)
4	H'2203	AVI analog input (XXX.XX%)
5	H'2204	ACI analog input (XXX.XX%)
6	H'2205	AUI analog input (XXX.XX%)

3. Parameter objects of Delta temperature controller (DTA) in the object dictionay

- Main index: H'2047-----communication parameters

Sub-index (hex)	Parameter address	Parameter function
1	H'4700	Process value
2	H'4701	Set value
3	H'4702	Upper limit alarm 1
⋮	⋮	⋮
1C	H'471B	Software version

Sub-index (hex)	Parameter address	Parameter funcion
2A	H'4729	AT setting
2C	H'472B	Error code
34	H'4733	CT monitor value

4. Parameter objects of Delta temperature controller (DTB) in the object dictionay

- Main index: H'2010-----communication parameter

Sub-index (hex)	Parameter address	Parameter funcion
1	H'1000	Process value
2	H'1001	Set value
3	H'1002	Upper-limit of temperature range
⋮	⋮	⋮
66	H'1065	Link pattern number setting of the correspond pattern
67	H'1066	Link pattern number setting of the correspond pattern
68	H'1067	Link pattern number setting of the correspond pattern

- Main index: H'2020-----communication parameters

Sub-index (hex)	Parameter address	Parameter funcion
1	H'2000	Setting up pattern 0 ~ 7 temperature set point
2	H'2001	Setting up pattern 0 ~ 7 temperature set point
3	H'2002	Setting up pattern 0 ~ 7 temperature set point
⋮	⋮	⋮
BE	H'20BD	Setting up pattern 0 ~ 7 excution time
BF	H'20BE	Setting up pattern 0 ~ 7 excution time
C0	H'20BF	Setting up pattern 0 ~ 7 excution time

- Main index: H'2047-----communication parameters

Sub-index (hex)	Parameter address	Parameter funcion
24	H'4723	Setting up control RUN/STOP
25	H'4724	Temperature unit
26	H'4725	Selecting decimal point position
27	H'4726	Selecting communication write-in
28	H'4727	PID AT setting
5B	H'475A	Setting up valve feedback status
2C	H'472B	Auto-tunning valve feedback status

5. Parameter objects of Delta servo drive (ASD-A) in object dictionay

- Main index: H'2000-----moniter parameters

Sub-index (hex)	Parameter No.	Parameter funcion
1	0-00H	Firmware version
2	0-01H	Drive error code

Sub-index (hex)	Parameter No.	Parameter funcion
3	0-02H	Drive status
⋮	⋮	⋮
F	0-14H	Block data read/write register 5
10	0-15H	Block data read/write register 6
11	0-16H	Block data read/write register 7

- Main index: H'2001-----basic parameters

Sub-index (hex)	Parameter No.	Parameter funcion
1	1-00H	Setting up external pulse input type
2	1-01H	Setting up control mode and input source of control instruction
3	1-02H	Setting up speed and torque limit
⋮	⋮	⋮
37	1-54H	Position completed width bits
38	1-55H	Maximum speed limit
39	1-56H	Output overload warning

- Main index: H'2002-----extension parameters

Sub-index (hex)	Parameter No.	Parameter funcion
1	2-00H	Proportional position loop gain
2	2-01H	Position loop gain switching rate
3	2-02H	Position feed forward gain
⋮	⋮	⋮
3F	2-63H	Electronic gear ratio
40	2-64H	Setting up proportion value setting
41	2-65H	Torque limit mixed mode

- Main index: H'2003-----communication parameters

Sub-index (hex)	Parameter No.	Parameter funcion
1	3-00H	Setting up communication address
2	3-01H	Communication speed
3	3-02H	Communication protocol
4	3-03H	Transmission error treatment
5	3-04H	Communication time-out detection
6	3-05H	Selecting communication port
7	3-06H	Communication control on digital input contact
8	3-07H	Communication feedback delay time

- Main index: H'2004-----diagnosis parameters

Sub-index (hex)	Parameter No.	Parameter funcion
1	4-00H	Recording error
2	4-01H	Recording error

Sub-index (hex)	Parameter No.	Parameter function
3	4-02H	Recording error
⋮	⋮	⋮
16	4-21H	Analog monitor output drift adjustment (ch2)
17	4-22H	Analog speed input drift value
18	4-23H	Analog torque input drift value

6. Parameter objects of Delta DVP series PLC in the object dictionary

- Main index: 3000H-----download area parameters (D device)

down → download start address

Sub-index (hex)	Parameter address	Parameter function	Parameter type
1	H'1000+down	D (down+0)	word
2	H'1001+down	D (down+1)	word
3	H'1002+down	D (down+2)	word
⋮	⋮	⋮	word
16	H'101D+down	D (down+29)	word
17	H'101E+down	D (down+30)	word
18	H'101F+down	D (down+31)	word

- Main index: H'3001-----upload area parameters (D device)

up → upload start address

Sub-index (hex)	Parameter address	Parameter function	Parameter type
1	H'1000+ up	D (up+0)	word
2	H'1001+ up	D (up +1)	word
3	H'1002+ up	D (up +2)	word
⋮	⋮	⋮	word
16	H'101D+ up	D (up +29)	word
17	H'101E+ up	D (up +30)	word
18	H'101F+ up	D (up +31)	word

- Main index: 3002H-----start address

Sub-index (hex)	Parameter function	Default value	Parameter type
1	Download start address	0	word
2	Upload start address	256 (0100H)	word

- Main index: H'3100 ~ H'3199-----step S

Index (hex)	Parameter address	Parameter function	Parameter type
3100/01	H'0000	S0	bit
3100/02	H'0001	S1	bit
⋮	⋮	⋮	bit
3100/FE	H'00FD	S253	bit
3101/01	H'0100	S256	bit

Index (hex)	Parameter address	Parameter funcion	Parameter type
3101/02	H'0101	S257	bit
⋮	⋮	⋮	bit
3101/FE	H'01FD	S509	bit
3102/01	H'0200	S512	bit
3102/02	H'0201	S513	bit
⋮	⋮	⋮	bit

- Main index: H'3200 ~ H'3299-----input point X

Index (hex)	Parameter address	Parameter funcion	Parameter type
3200/01	H'0400	X0	bit
3200/02	H'0401	X1	bit
⋮	⋮	⋮	bit
3200/FE	04FDH	X375	bit

- Main index: H'3300 ~ H'3399-----input point Y

Index (hex)	Parameter address	Parameter funcion	Parameter type
3300/01	H'0500	Y0	bit
3300/02	H'0501	Y1	bit
⋮	⋮	⋮	bit
3300/FE	H'05FD	Y375	bit

- Main index: H'3400 ~ H'3499-----timer T (bit device)

Index (hex)	Parameter address	Parameter funcion	Parameter type
3400/01	H'0600	T0	bit
3400/02	H'060	T1	bit
⋮	⋮	⋮	bit
3400/FE	H'06FD	T253	bit

- Main index: H'3500 ~ H'3599-----timer T (word device)

Index (hex)	Parameter address	Parameter funcion	Parameter type
3500/01	H'0600	T0	word
3500/02	H'0601	T1	word
⋮	⋮	⋮	word
3500/FE	H'06FD	T253	word

- Main index: H'3600 ~ H'3699-----auxiliary relay M

Index (hex)	Parameter address	Parameter funcion	Parameter type
3600/01	H'0800	M0	bit
3600/02	H'0801	M1	bit
⋮	⋮	⋮	bit
3600/FE	H'08FD	M253	bit

Index (hex)	Parameter address	Parameter funcion	Parameter type
3601/01	H'0900	M256	bit
3601/02	H'0901	M257	bit
⋮	⋮	⋮	bit
3601/FE	H'09FD	M509	bit
3602/01	H'0A00	M512	bit
3602/02	H'0A01	M513	bit
⋮	⋮	⋮	bit

- Main index: H'3700 ~ H'3799-----counter C (bit device)

Index (hex)	Parameter address	Parameter funcion	Parameter type
3700/01	H'0E00	C0	bit
3700/02	H'0E01	C1	bit
⋮	⋮	⋮	bit
3700/FE	H'0EFD	C253	bit

- Main index: H'3800 ~ H'3899-----counter C (word device)

Index (hex)	Parameter address	Parameter funcion	Parameter type
3800/01	H'0E00	C0	word
3800/02	H'0E01	C1	word
⋮	⋮	⋮	word
3800/C8	H'0EC7	C199	word
3800/C9	H'0EC8	C200	Dword
3800/CA	H'0EC9	C201	Dword
⋮	⋮	⋮	word
3800/FE	H'0EFD	C253	Dword

- Main index: H'3900 ~ H'3999-----register D

Index (hex)	Parameter address	Parameter funcion	Parameter type
3900/01	H'1000	D0	word
3900/02	H'1001	D1	word
⋮	⋮	⋮	word
3900/FE	H'10FD	D253	word
3901/01	H'1100	D256	word
3901/02	H'1101	D257	word
⋮	⋮	⋮	word
3901/FE	H'11FD	D509	word
3902/01	H'1200	D512	word
3902/02	H'1201	D513	word
⋮	⋮	⋮	word

7. Parameter objects of Delta DOP-A series HMI in yjr object dictionay

Virtual D parameters of IFD9503 arel listed as bellow:

- Main index: H'4000-----download area parameters

Sub-index (hex)	Parameter address	Parameter funcion	Parameter type
1	H'1000	D0	word
2	H'1001	D1	word
3	H'1002	D2	word
⋮	⋮	⋮	word
18	H'101D	D29	word
19	H'101E	D30	word
20	H'101F	D31	word

- Main index: H'4001-----upload area parameters

Sub-index (hex)	Parameter No.	Parameter funcion	Parameter type
1	H'1020	D32	word
2	H'1021	D33	word
3	H'1022	D34	word
⋮	⋮	⋮	word
18	H'103D	D61	word
19	H'103E	D62	word
20	H'103F	D63	word

8. Parameter objects of custom equipment in the object dictionary

- Main index: H'5000-----download area parameters

Sub-index (hex)	Parameter funcion
1	1 st word of RxPDO 1
2	2 nd word of RxPDO 1
3	3 rd word of RxPDO 1
4	4 th word of RxPDO 1
5	1 st word of RxPDO 2
6	2 nd word of RxPDO 2
7	3 rd word of RxPDO 2
8	4 th word of RxPDO 2
9	1 st word of RxPDO 3
A	2 nd word of RxPDO 3
B	3 rd word of RxPDO 3
C	4 th word of RxPDO 3
D	1 st word of RxPDO 4
E	2 nd word of RxPDO 4
F	3 rd word of RxPDO 4
10	4 th word of RxPDO 4
11	1 st word of RxPDO 5
12	2 nd word of RxPDO 5
13	3 rd word of RxPDO 5

Sub-index (hex)	Parameter function
14	4 th word of RxPDO 5
15	1 st word of RxPDO 6
16	2 nd word of RxPDO 6
17	3 rd word of RxPDO 6
18	4 th word of RxPDO 6
19	1 st word of RxPDO 7
1A	2 nd word of RxPDO 7
1B	3 rd word of RxPDO 7
1C	4 th word of RxPDO 7
1D	1 st word of RxPDO 8
1E	2 nd word of RxPDO 8
1F	3 rd word of RxPDO 8
20	4 th word of RxPDO 8

- Main index: H'5001-----upload area parameters

Sub-index (hex)	Parameter function
1	1 st word of TxPDO 1
2	2 nd word of TxPDO 1
3	3 rd word of TxPDO 1
4	4 th word of TxPDO 1
5	1 st word of TxPDO 2
6	2 nd word of TxPDO 2
7	3 rd word of TxPDO 2
8	4 th word of TxPDO 2
9	1 st word of TxPDO 3
A	2 nd word of TxPDO 3
B	3 rd word of TxPDO 3
C	4 th word of TxPDO 3
D	1 st word of TxPDO 4
E	2 nd word of TxPDO 4
F	3 rd word of TxPDO 4
10	4 th word of TxPDO 4
11	1 st word of TxPDO 5
12	2 nd word of TxPDO 5
13	3 rd word of TxPDO 5
14	4 th word of TxPDO 5
15	1 st word of TxPDO 6
16	2 nd word of TxPDO 6
17	3 rd word of TxPDO 6
18	4 th word of TxPDO 6

Sub-index (hex)	Parameter function
19	1 st word of TxPDO 7
1A	2 nd word of TxPDO 7
1B	3 rd word of TxPDO 7
1C	4 th word of TxPDO 7
1D	1 st word of TxPDO 8
1E	2 nd word of TxPDO 8
1F	3 rd word of TxPDO 8
20	4 th word of TxPDO 8

6 Connection of IFD9503 with Other Equipment

1. Communication wirings when connected to equipment through PORT1.

- When IFD9503 is connected to Delta VFD series AC motor drive:

By RS-485 communication; using standard cable with RJ-12 connectors is suggested.

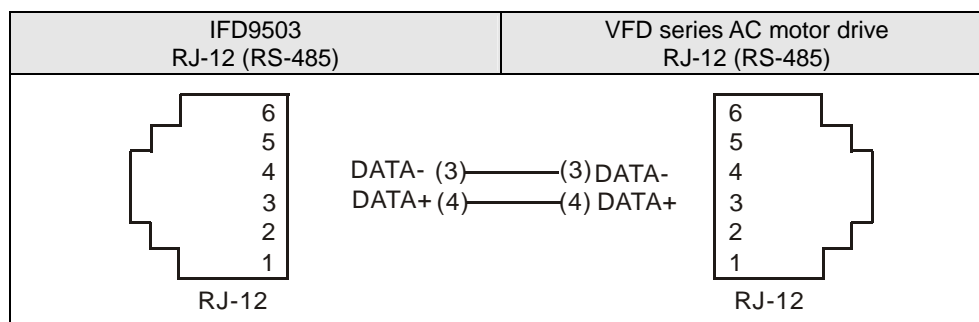

- When IFD9503 is connected to Delta DVP series PLC:

By RS-485 communication

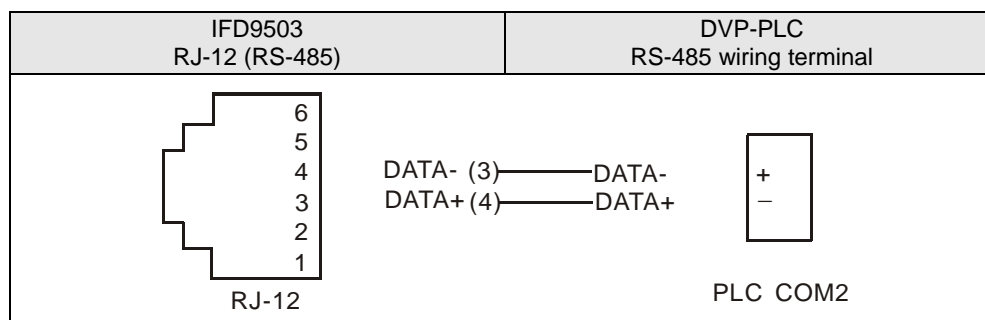

- When IFD9503 is connected to Delta DTA/DTB series temperature controller:

By RS-485 communication

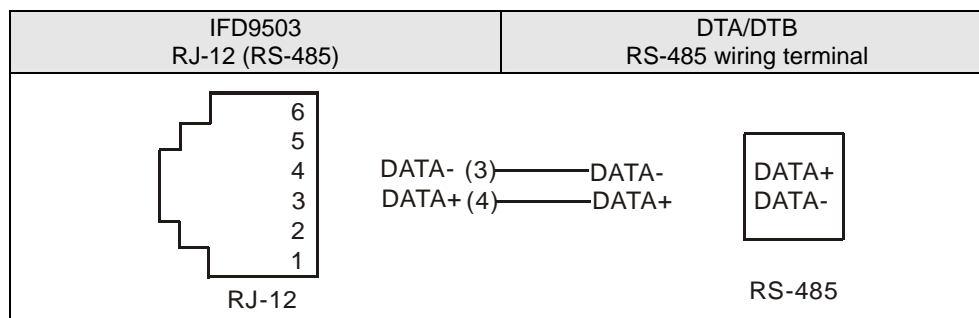

- When IFD9503 is connected to Delta ASD-A series servo drive:

By RS-485 communication

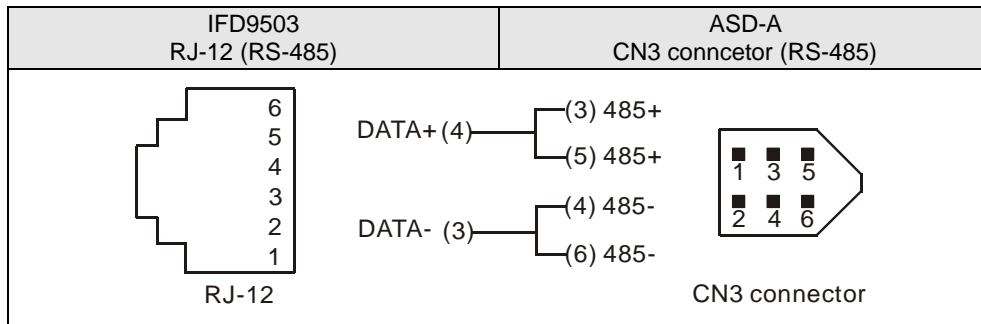

- When IFD9503 is connected to Delta DOP series human machine interface:

By RS-485 communication

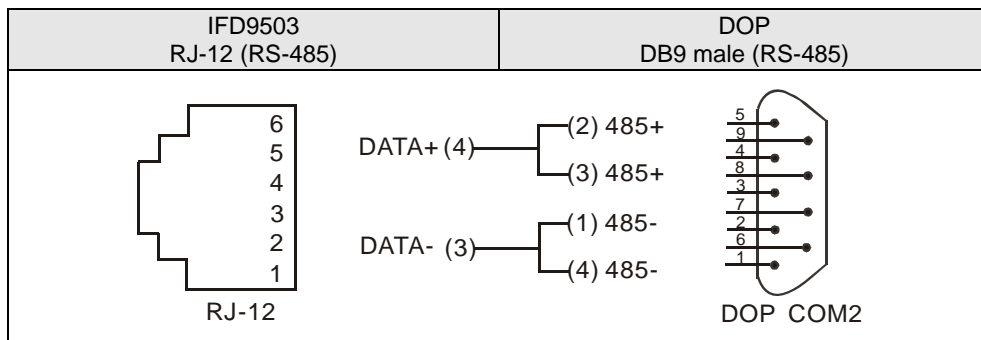

2. Communication wirings when connected to equipment through PORT2.

- When IFD9503 is connected to Delta VFD series AC motor drive:

By RS-485 communication

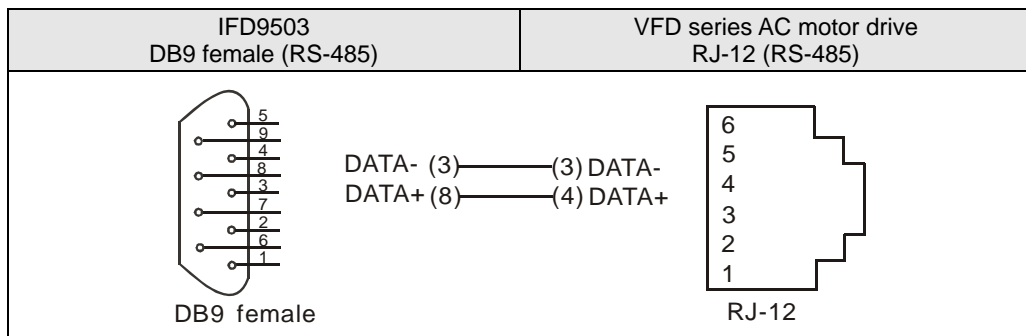

- When IFD9503 is connected to Delta DVP series PLC:

By RS-232 communication; using standard DVPACAB215/DVPACAB230 is suggested.

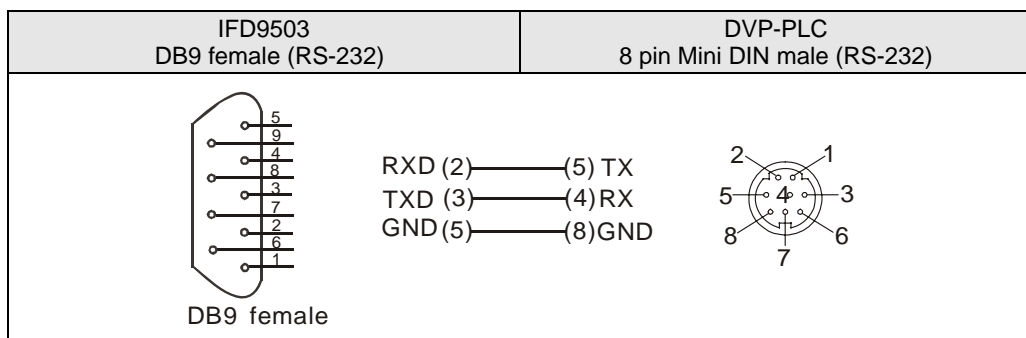

By RS-485 communication

